

# Argentina Livestock

Protocol | Version 1.0 | October 2, 2024



CLIMATE  
ACTION  
RESERVE

*Climate Action Reserve*  
*[www.climateactionreserve.org](http://www.climateactionreserve.org)*

*Released October 2, 2024*

*© 2024 Climate Action Reserve. All rights reserved. This material may not be reproduced, displayed, modified, or distributed without the express written permission of the Climate Action Reserve.*

## Acknowledgements

### Reserve staff (alphabetical)

#### Version 1.0

Amy Kessler

Claudia Benitez Jurado

Rachel Mooney

### Workgroup

The list of workgroup members below comprises all individuals and organizations that have advised the Reserve in development of this protocol and have provided independent expert review. Their participation in the Reserve process is based on their technical expertise and does not constitute endorsement of the final protocol. The Reserve makes all final technical decisions and approves final protocol content. For more information about the protocol development process, refer to the Reserve Offset Program Manual.

Bret Consultores

Displaced Carbon Committee - Government of Córdoba

Ecosecurities

Génesis

HINS Renewable Energy Company

MEXICO2

Ministry of Bioagroindustry - Government of Córdoba

Ministry of Infrastructure and Public Services of Córdoba

Ministry of Production – Corrientes Province

National Technological University

National University of La Plata

Secretariat of Livestock of Córdoba

Secretariat for Energy Transition - Ministry of Infrastructure and Public Services- Government of Córdoba

Secretary of Energy Planning- Government of Córdoba

Segam Consulting and Government of Córdoba

Subsecretary of the Nation's Environment

Rene Ibarra

Marine Iriart

Federico Fritz

Laura Garzón

Javier Slythe

Yulissa Camacho

Catalina Boetto

Pablo Gabutti

Raúl Eduardo Ortiz

Ariel Clebañer

Guillermo Piovano

Martina Solenot

Juan Martin Lemos

Pamela Zanel

Marcos Cena

Agustina Cundari

### Financial and Technical Support

This document was developed with partial financial and technical support from the Province of Cordoba and MÉXICO<sub>2</sub> – Plataforma Mexicana de Carbono.

## Table of Contents

Abbreviations and Acronyms.....	7
1 Introduction.....	1
2 The GHG Reduction Project.....	2
2.1 Project Definition .....	2
2.2 The Project Developer .....	2
2.3 Additional Manure Management GHG Reduction Activities .....	3
3 Eligibility Rules.....	4
3.1 Location.....	4
3.2 Project Start Date .....	4
3.3 Project Crediting Period.....	5
3.4 Anaerobic Baseline.....	5
3.5 Additionality .....	6
3.5.1 The Performance Standard Test.....	6
3.5.2 Limits on Credit Stacking .....	6
3.5.3 The Legal Requirement Test.....	7
3.6 Regulatory Compliance .....	8
3.7 Social and Environmental Safeguards .....	8
4 The GHG Assessment Boundary .....	11
5 Quantifying GHG Emission Reductions.....	18
5.1 Required Parameters for Modeling Baseline and Project Emissions.....	19
5.2 Modeling Baseline Methane Emissions.....	22
5.3 Calculating Project Methane Emissions.....	27
5.3.1 Modeled Methane Destruction .....	27
5.3.2 Metered Methane Destruction Comparison.....	35
5.3.3 Determining Methane Emission Reductions.....	35
5.4 Calculating Baseline and Project Carbon Dioxide Emissions .....	36
6 Project Monitoring.....	38
6.1 Site-Specific Determination of Maximum Methane Potential ( $B_0$ ) .....	38
6.2 Monitoring Requirements.....	40
6.3 Biogas Measurement Instrument QA/QC.....	43
6.3.1 Missing Data .....	44
6.4 Monitoring Parameters .....	45
7 Reporting Parameters.....	55
7.1 Project Documentation .....	55
7.1.1 Project Data Report .....	55

---

7.2	Record Keeping.....	56
7.3	Reporting Period and Verification Cycle.....	57
7.3.1	Reporting Periods.....	57
7.3.2	Verification Periods.....	57
7.3.3	Verification Site Visit Schedule .....	57
8	Verification Guidance.....	59
8.1	Standard of Verification .....	59
8.2	Monitoring Plan.....	59
8.3	Verifying Project Eligibility.....	60
8.4	Core Verification Activities .....	61
8.5	Verification Period .....	62
8.5.1	Option 1: Twelve-Month Maximum Verification Period .....	62
8.5.2	Option 2: Twelve-Month Verification Period with Desktop Verification.....	62
8.5.3	Option 3: Twenty-Four Month Maximum Verification Period.....	62
8.6	Livestock Verification Items .....	63
8.6.1	Project Eligibility and CRT Issuance .....	63
8.6.2	Quantification.....	64
8.6.3	Risk Assessment .....	65
8.7	Completing Verification.....	66
9	Glossary of Terms.....	67
10	References .....	71
Appendix A	Associated Environmental and Social Impacts.....	73
Appendix B	Emission Factor Tables .....	76
Appendix C	Summary of the Performance Standard Analysis.....	94
Appendix D	Data Substitution .....	100
Appendix E	Development of the B <sub>0</sub> Sampling and Analysis Methodology .....	102
Appendix F	Sample Livestock Project Diagram .....	106

## List of Tables

Table 4.1. Description of all Sources, Sinks, and Reservoirs.....	14
Table 6.1. Project Monitoring Parameters .....	46
Table 8.1. Summary of Eligibility Criteria for a Livestock Project .....	60
Table 8.2. Eligibility Verification Items .....	63
Table 8.3. Quantification Verification Items .....	64
Table 8.4. Risk Assessment Verification Items.....	66
Table B.1. Manure Management System Components .....	76
Table B.2. Livestock Categories and Typical Average Mass .....	78
Table B.3. Volatile Solids and Maximum Methane Potential by Livestock Category .....	79
Table B.4. IPCC 2019 Methane Conversion Factors by Manure Management System Component/Methane Source ‘S’ .....	80
Table B.5. Emission Factor for Stationary and Mobile Combustion .....	90
Table B.6. Fossil Fuel Net Calorific Values .....	91
Table B.7. Biogas Destruction Efficiency Default Values by Destruction Device.....	92
Table E.1. Effects of Relative Population Size on Composite B <sub>0</sub> Value .....	104

## List of Figures

Figure 3.1. Sample Timeline for a project with a 9-month start-up testing period.....	4
Figure 4.1. General Illustration of the GHG Assessment Boundary .....	13
Figure 5.1. Organizational Chart for Equations in Section 5 .....	21
Figure 6.1. Suggested Arrangement of Biogas Metering Equipment .....	42
Figure C.1. Stock of beef cattle in Argentina .....	95
Figure C.2. Location of the known biodigesters in Argentina.....	98
Figure E.1. Monthly Milk Production Trends as a Percent Change Over Annual Average Monthly Milk Production (2015-2023) .....	103

## List of Equations

Equation 5.1. GHG Reductions from Installing a Biogas Control System .....	22
Equation 5.2. Modeled Baseline Methane Emissions .....	23
Equation 5.3. Modeled Baseline Methane Emissions from Anaerobic Storage/Treatment Systems .....	23
Equation 5.4. Modeled Baseline Methane for Non-Anaerobic Storage/Treatment Systems .....	26
Equation 5.5. Project Methane Emissions .....	28
Equation 5.6. Project Methane Emissions from the Biogas Control System .....	29
Equation 5.7. Methane Emissions from Venting Events .....	31
Equation 5.8. Project Methane Emissions from the BCS Effluent Pond.....	32
Equation 5.9. Project Methane Emissions from <i>Non</i> -Biogas Control System Related Sources .	34
Equation 5.10. Metered Methane Destruction .....	35
Equation 5.11. Carbon Dioxide Emission Calculations .....	37

## Abbreviations and Acronyms

BCS	Biogas Control System
CDM	Clean Development Mechanism
CH <sub>4</sub>	Methane
CNG	Condensed natural gas
CO <sub>2</sub>	Carbon dioxide
CRT	Climate Reserve Tonne
EPA	Environmental Protection Agency
FPIC	Free, Prior, and Informed Consent
GHG	Greenhouse gas
GN	Natural gas
IPCC	Intergovernmental Panel on Climate Change
LNG	Liquefied natural gas
MRV	Monitoring, Reporting, and Verification
N <sub>2</sub> O	Nitrous oxide
NCCCDM	National Council for Climate Change and Clean Development Mechanism
NRCS	Natural Resources Conservation Service
QA/QC	Quality Assurance / Quality Control
Reserve	Climate Action Reserve
RENSPA	National Health Registry of Agricultural Producers in Argentina



SENASA	National Service of Health and Quality of Agricultural Foods
UNFCCC	United Nations Framework Convention on Climate Change
USDA	United States Department of Agriculture

# 1 Introduction

The Climate Action Reserve (Reserve) Argentina Livestock Protocol provides guidance to account for and report greenhouse gas (GHG) emission reductions associated with the installation of a biogas control system (BCS) for manure management on dairy cattle, beef cattle, and swine farms. The Protocol focuses on quantifying the change in methane emissions, but also accounts for effects on carbon dioxide emissions.

The Climate Action Reserve is the most trusted, efficient, and experienced offset registry for global carbon markets. A pioneer in carbon accounting, the Reserve promotes and fosters GHG emissions through credible market-based policies and solutions. As a high-quality offset registry for voluntary carbon markets, it establishes rigorous standards involving multi-sector stakeholder workgroup development and local engagement and issues carbon credits in a transparent and publicly available system. The Reserve also supports compliance carbon markets in California, Washington, and internationally. The Reserve is an environmental nonprofit organization headquartered in Los Angeles, California with satellite offices around the world. For more information, please visit [www.climateactionreserve.org](http://www.climateactionreserve.org).

Project developers that install manure biogas capture and destruction technologies use this document to register GHG reductions with the Reserve. The Protocol provides eligibility rules, methods to calculate reductions, performance-monitoring instructions, and procedures for reporting project information to the Reserve. Additionally, all project reports receive independent verification by Reserve-approved verification bodies. Guidance for verification bodies to verify reductions is provided in the Verification Program Manual and Section 8 of this protocol.

The Reserve develops protocols aligned with the laws, norms, and on-the-ground context of a specific jurisdiction or jurisdictions to establish standardized eligibility and additional criteria and baseline scenarios. This Protocol is thus aligned with the laws, norms, and context of Argentina. See Section(s) 3.5.3 and Appendix C for further information on how these laws were incorporated in the Performance Standard Test.

This project protocol facilitates the creation of GHG emission reductions determined in a complete, consistent, transparent, accurate, and conservative manner, while incorporating relevant sources.<sup>1</sup>

---

<sup>1</sup> See the WRI/WBCSD GHG Protocol for Project Accounting (Part I, Chapter 4) for a description of GHG accounting principles.

## 2 The GHG Reduction Project

Manure treated and stored under anaerobic conditions decomposes to produce methane, which, if uncontrolled, is emitted to the atmosphere. This predominantly occurs when livestock operations manage waste with anaerobic liquid-based systems (e.g., in lagoons, ponds, tanks, or pits). Within the livestock sector, the primary drivers of methane generation include the amount of manure produced and the fraction of volatile solids that decompose anaerobically. Temperature and the retention time of manure during treatment and storage also affect its production. A biogas control system captures and destroys methane gas created as a result of manure management.

### 2.1 Project Definition

For the purpose of this Protocol, the GHG reduction project is defined as the installation of a biogas control system<sup>2</sup> that captures and destroys methane gas from anaerobic manure treatment and/or storage facilities on livestock operations, specifically dairy cattle, beef cattle, and swine operations (referred to hereafter as “livestock”). The biogas control system must destroy methane gas that would otherwise have been emitted to the atmosphere in the absence of the project from uncontrolled anaerobic treatment and/or storage of manure.<sup>3</sup>

Captured biogas can be destroyed on-site, or transported for off-site use (e.g., through gas distribution or transmission pipeline), or used to power vehicles. Regardless of how project developers take advantage of the captured biogas, the ultimate fate of the methane must be destruction.

“Centralized digesters” that integrate waste from more than one livestock operation also meet this definition of the GHG reduction project.<sup>4</sup>

### 2.2 The Project Developer

The “project developer” is an entity that has an active account on the Reserve, submits a project for listing and registration with the Reserve, and is ultimately responsible for all project reporting and verification. Project developers could be livestock facility owners and operators<sup>5</sup>, GHG project financiers, or other entities. The project developer must have clear ownership of the project’s GHG reductions. Ownership of the GHG reductions must be established by clear and explicit title,<sup>6</sup> such as through a legal contract to transfer the rights to the project’s GHG

---

<sup>2</sup> Biogas control systems are commonly called digesters, which may be designed and operated in a variety of ways, from ambient temperature covered lagoons to heated lagoons to mesophilic plug flow or complete mix concrete tank digesters.

<sup>3</sup> The installation of a BCS at an existing livestock operation where the primary manure management system is aerobic (produces little to no methane) may result in an increase of the amount of methane emitted to the atmosphere. Thus, the BCS must digest manure that would primarily be treated in an anaerobic system in the absence of the project in order for the project to meet the definition of a GHG reduction project.

<sup>4</sup> The protocol also does not preclude project developers from co-digesting organic matter in the biogas control system. However, the additional organics could impact the nutrient properties of digester effluent, which project developers should consider when assessing the project’s associated water quality impacts.

<sup>5</sup> Livestock “operators” refers to the entity that owns/operates the livestock facility.

<sup>6</sup> Verifiers may refer to the National Registry of Rural Workers and Employers for additional information regarding ownership in Argentina, as well as the appropriate Provincial registry.

emission reductions to another entity. The project developer must attest to such ownership by signing the Reserve's Attestation of Title form.<sup>7</sup>

Facilities that host livestock owned by a third party, commonly referred to as “*hotelerías*” in Argentina, must advise the third-party livestock owners of the existence of a carbon project on the facility and clarify that the GHG emission reduction rights remain with the livestock facility operator.

### **2.3 Additional Manure Management GHG Reduction Activities**

The Reserve recognizes that project developers could implement a variety of GHG reduction activities at a livestock operation, which are complex interrelated systems that make use of several types and combinations of manure management practices. Installing technology to capture and destroy methane from waste storage and/or treatment systems is but one of many projects that could occur at a livestock operation. Several options to modify solid and/or liquid manure management practices that do not involve a biogas control system – i.e., a digester – could also reduce methane, carbon dioxide, and nitrous oxide emissions (including land application). And a project developer could also change dietary regimes to reduce methane (either enteric fermentation or waste management-related) and nitrous oxide.

However, at this time, GHG reduction activities not associated with installing a biogas control system do not meet this protocol's definition of the GHG reduction project. Furthermore, producing power for the electricity grid (and thus displacing fossil-fueled power plant GHG emissions) is a complementary and separate GHG project activity to destroying methane gas from waste treatment/storage, and is not included within this protocol's accounting framework.

---

<sup>7</sup> Attestation of Title form available at <https://www.climateactionreserve.org/how/program-resources/documents/>.

### 3 Eligibility Rules

Project developers using this Protocol satisfy the following eligibility rules to register reductions with the Reserve. The criteria only apply to projects that meet the definition of a GHG reduction project.

<b>Eligibility Rule I:</b>	Location	→	<i>Argentina</i>
<b>Eligibility Rule II:</b>	Project Start Date	→	<i>Within 12 months prior to project submission</i>
<b>Eligibility Rule III:</b>	Anaerobic Baseline	→	<i>Demonstrate anaerobic baseline conditions</i>
<b>Eligibility Rule IV:</b>	Additionality	→	<i>Meet performance standard</i>
		→	<i>Avoid exceeding limits on credit stacking</i>
		→	<i>Exceed legal requirements</i>
<b>Eligibility Rule V:</b>	Regulatory Compliance	→	<i>Compliance with all applicable laws</i>

#### 3.1 Location

Only projects located in Argentina are eligible to register reductions with the Reserve under this protocol. Livestock projects located in the United States, Mexico, or Dominican Republic must use the respective Livestock Protocol if seeking to register GHG reductions with the Reserve.

#### 3.2 Project Start Date

The start date for a livestock project is defined as the date at which the project’s biogas control system becomes operational. For the purposes of this protocol, a biogas control system (BCS) is considered *operational* on the date at which the system begins producing and destroying methane gas upon completion of an initial start-up period. This date can be selected by the project developer within a 9-month timeframe from the date at which methane is first produced in the digester.

Projects must be submitted to the Reserve no more than 12 months after the project start date.

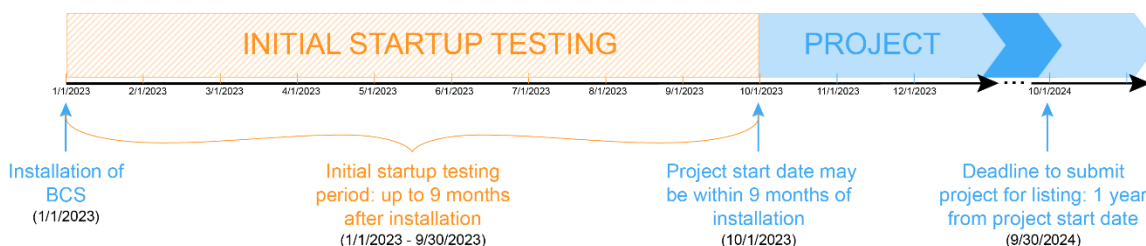

Figure 3.1. Sample Timeline for a project with a 9-month start-up testing period

Projects with previous destruction that have been inactive<sup>8</sup> may be allowed to come back online under the Argentina Livestock Protocol as long as the project developer can demonstrate that the project can still be considered additional. The Reserve maintains the right to determine if the project is eligible. Contact the Reserve prior to project submittal to determine the eligibility of an inactive project.

### 3.3 Project Crediting Period

Project developers are eligible to register GHG reductions with the Reserve according to this protocol for a period of 10-years following the project's operational start date. However, if a regulatory agency with authority over a livestock operation passes a rule obligating the installation of a biogas control system, the Reserve will only issue CRTs for GHG reductions achieved up until the date that the biogas control system is legally required to be operational. See Section 3.5.3 for more information.

At the end of a project's first crediting period, a project developer may apply for eligibility under a second crediting period. Thus, the Reserve may issue CRTs for GHG reductions quantified and verified according to the Argentina Livestock Protocol for a maximum of two ten-year crediting periods after the project start date. Section 3.5.1 and 3.5.3 describe the requirements to qualify for a second crediting period.

### 3.4 Anaerobic Baseline

Consistent with CDM methodology ACM0010<sup>9</sup>, project developers must demonstrate that the depth of their anaerobic ponds/lagoons pre-project were sufficient to prevent algal oxygen production and create an oxygen-free bottom layer; which usually means at least 1 meter depth. Ultimately, to generate methane emissions anaerobic systems should be designed and maintained with sufficient volume to properly treat volatile solids and prevent solids from accumulating to the extent that they adversely impact the treatment zone. Additional information on the design and maintenance of anaerobic manure storage/treatment systems is available through the National Entity for Sanitation Waterworks (ENOHSA) and Decree 847/16 Regulation of Standards on Discharges for the Preservation of Water Resources.<sup>10</sup> See USDA NRCS Standards for additional information.<sup>11</sup>

Greenfield livestock projects (i.e., projects that are implemented at new livestock facilities that have no prior manure management system) are eligible only if the project developer can demonstrate that uncontrolled anaerobic storage and/or treatment of manure is common practice in the industry and geographic region where the project is located.

---

<sup>8</sup> For example, the African Swine Fever, Avian Bird Flu, or other infectious diseases that impact the facility's operations.

<sup>9</sup> See United Nations, Carbon Offset Platform, ACM0010: Consolidated methodology for GHG emission reductions from manure management systems --- Version 3.0. Available at: <https://cdm.unfccc.int/methodologies/DB/66DCX9DCDE8UFYYIHJEY5NRPAA8WNE/view.html>

<sup>10</sup> See the Ministry of Water, Environment, and Public Utilities, Decree 847/16 – Regulation of Standards on Discharge for the Preservation of Water Resources. Available at: <http://boletinoficial.cba.gov.ar/wp-content/4p96humuzp/2016/07/847-dec.pdf> .

<sup>11</sup> U.S. Department of Agriculture Natural Resources Conservation Service, Conservation Practice Standard, Waste Storage Facility, No. 313; and U.S. Department of Agriculture Natural Resources Conservation Service, Conservation Practice Standard, Waste Treatment Lagoon, No. 359

### 3.5 Additionality

The Reserve will only accept projects that yield surplus GHG reductions that are additional to what might have otherwise occurred. That is, the reductions are above and beyond business-as-usual operation.

Project developers satisfy the “additionality” eligibility rule by passing two tests:

1. The Performance Standard Test
2. The Legal Requirement Test

#### 3.5.1 The Performance Standard Test

Project developers pass the Performance Standard Test by meeting a program-wide performance threshold – i.e., a standard of performance applicable to all manure management projects, established on an ex-ante basis. The performance threshold represents “better than business-as-usual.” If the project meets the threshold, then it exceeds what would happen under the business-as-usual scenario and generates surplus/additional GHG reductions.

For this Protocol, the Reserve uses a technology-specific threshold; sometimes also referred to as a practice-based threshold, where it serves as “best-practice standard” for managing livestock manure. By installing a biogas control system, a project developer passes the Performance Standard Test.

The Reserve defined this performance standard by evaluating manure management practices in Argentina. A summary of the study to establish the threshold is provided in Appendix C.

The Performance Standard Test is applied at the time of the project’s start date. All projects that pass this test at the project’s start date are eligible to register reductions with the Reserve for the duration of the first project crediting period, even if the Reserve revises the Performance Standard Test in subsequent versions of this protocol during that period. As stated in Section 3.3, the project crediting period is 10-years.

If a project developer wishes to apply for a second crediting period, the project must meet the eligibility requirements of the most current version of this protocol, including any updates to the Performance Standard Test.

#### 3.5.2 Limits on Credit Stacking

When multiple forms of incentive credits are sought for a single activity at a single facility or on a single piece of land, with some temporal overlap between the different credits or payments, it is referred to as “credit stacking”. Under this protocol, credit stacking is defined as receiving both carbon credits and other types of mitigation credits for the same activity on spatially overlapping areas (e.g., in the same digester). Mitigation credits are any instruments issued for the purpose of offsetting the environmental impacts of another entity, such as emissions of GHGs, or the displacement of fossil fuel emissions from transport applications, to name a few.

Project developers are strongly encouraged to reach out to the Reserve as early as possible when considering credit stacking. Furthermore, they must disclose any such credits or payments to the Reserve at the time of listing and any time stacking occurs during a project’s

crediting period, and to the verification body and the Reserve at the time of verification. The Reserve maintains the right to determine if stacking has occurred, or is occurring, and if approved, to ensure additionality and that all other eligibility requirement can be met, and to avoid double-counting.

If a livestock project transitions to reporting under another standard but may wish to receive CRTs in future reporting periods, the project must maintain continuous reporting with the Reserve under the Argentina Livestock Protocol. To maintain continuous reporting, the project developer must submit a Zero-Credit Reporting Period Acknowledgment and Election form and a Monitoring Report no later than six months following the end of each relevant reporting period under the other fuel standard.

### 3.5.3 The Legal Requirement Test

All projects are subject to a Legal Requirement Test to ensure that the GHG reductions achieved by a project would not otherwise have occurred due to national, provincial, or local regulations, or other legally binding mandates. A project passes the Legal Requirement Test when there are no laws, statutes, regulations, court orders, environmental mitigation agreements, permitting conditions, or other legally binding mandates requiring the installation of a BCS at the livestock operation.

The Legal Requirement Test is applied at the time of the project's start date and each reporting period thereafter. To satisfy the Legal Requirement Test, project developers must submit a signed Attestation of Voluntary Implementation form<sup>12</sup> prior to the commencement of verification activities each time the project is verified. In addition, the project's Monitoring Plan (Section 6) must include procedures that the project developer will follow to ascertain and demonstrate that the project at all times passes the legal requirement test. If an eligible project begins operation and later becomes subject to a regulation, ordinance, or permitting condition obligating the installation of a biogas control system, emission reductions can be registered in the Reserve from the project start date until the date that the biogas control system is legally required to be operational. Similarly, if methane emissions generated from the livestock sector are included under an emissions cap (e.g., under a local, provincial, or federal cap-and-trade program), emission reductions may likewise be reported to the Reserve until the date that the emissions cap takes effect.

If a project developer wishes to apply for a second crediting period, the project must meet the eligibility requirements of the most current version of this protocol, including any updates to the Legal Requirement Test.

The Reserve's analysis of manure management practices in Argentina found no national, provincial, or municipal regulation that requires the investment in a manure biogas control system.

---

<sup>12</sup> Attestation forms are available at <https://www.climateactionreserve.org/how/program-resources/documents/>



### 3.6 Regulatory Compliance<sup>13</sup>

As a final eligibility requirement, project developers must attest that the project is in compliance with all laws applicable to the project activity (e.g., air, water quality, worker safety<sup>14</sup>, animal welfare<sup>15</sup>, etc.). To satisfy this requirement, project developers must submit a signed Attestation of Regulatory Compliance form<sup>16</sup> prior to commencement of verification activities for each verification period. Project developers are required to disclose in writing to the verifier any and all instances of legal violations – material or otherwise – caused by the project or project activities.

A violation should be considered “caused” by project activities if it can be reasonably argued that the violation would not have occurred in the absence of the project activities. If there is any question of causality, the project developer shall disclose the violations to the verifier.

If a verifier determines that project activities have caused a material violation, then CRTs will not be issued for GHG reductions that occurred during the period(s) when the violation occurred. Individual violations due to administrative or reporting issues, or due to “acts of nature,” are not considered material and will not affect CRT crediting. However, recurring non-compliance or non-compliance that is the result of negligence or intent may affect crediting. Verifiers must determine if recurrent violations rise to the level of materiality. If the verifier is unable to assess the materiality of the violation, then the verifier shall consult with the Reserve.

With respect to projects that receive and manage manure from multiple discrete source facilities (separate from the BCS project in both physical location and management), it may be possible for a project developer to demonstrate that a regulatory violation occurring at one source facility does not affect the eligibility of the entire project under this section. Project developers should contact the Reserve to report potential non-compliance issues.

### 3.7 Social and Environmental Safeguards

The Reserve requires project developers to demonstrate that their GHG projects will not give rise to environmental or social harm. Moreover, offset projects can create long-term social and environmental benefits and have the potential to improve quality of life for rural landowners, both in terms of increased revenues and in terms of sustaining and improving livestock practices and lands.

This Protocol includes specific social and environmental safeguards that must be considered in the project design and implemented throughout the project life to help guarantee that the project will have positive environmental and social outcomes. In addition, all projects must comply with the Reserve’s Offset Program Manual, including the section on regulatory compliance and

---

<sup>13</sup> Refer to A.1 for an analysis of regulations in Argentina applicable to livestock operations.

<sup>14</sup> Projects must be in regulatory compliance with Law No. 19,587 on Occupational Hygiene and Safety, Decree 617/97-Regulation of Hygiene and Safety for Agricultural Activity, and Law 26.727 Agricultural Labor, as well as any other national and provincial labor laws. Verifiers should refer to the National Registry of Rural Workers and Employers (Spanish abv. RENATRE) to confirm compliance at a national level and the appropriate provincial agency if applicable.

<sup>15</sup> The National Health Service and Agrifood Quality (Spanish abv SENASA) within the Bureau of Animal Health Control is in charge of Argentina’s Animal Welfare Program. Refer to the Manuals of Good Practices available at: <https://www.senasa.go.cr/informacion/manuales-de-buenas-practicas>

<sup>16</sup> Attestation forms are available at <https://www.climateactionreserve.org/how/program-resources/documents/>

programmatic environmental and social safeguards. The safeguards in the protocol are intended to respect governmental processes, customs, and rights of landowners while ensuring projects are beneficial, both socially and environmentally. The sections on monitoring, reporting, and verification (MRV) (Sections 7 and 8) specify the criteria for verification of each of these safeguards and consequences for failure to achieve the minimum thresholds.

The social safeguards requirements include:

1. Free, Prior, and Informed Consent (FPIC):
  - a. Project developers must address the following topics with the livestock operator<sup>17</sup> prior to project approval:
    - i. Concepts of climate change and carbon markets.
    - ii. Requirements associated with livestock projects, including ongoing MRV.
    - iii. Estimates of costs and benefits associated with the livestock project and the division of costs and distribution of benefits or benefit sharing. The source used for carbon pricing estimates must be disclosed to the livestock operator.
  - b. After the topics to comply with 1.a (see above) have been addressed, livestock operators must approve the livestock carbon project and the project developer.
2. Ongoing Notification, Participation, and Documentation:
  - a. The project developer must review with the livestock operator on an annual basis the following topics:
    - i. Ongoing project activities, including MRV.
    - ii. Credits issued.
    - iii. Purchase agreements, project finances, and ongoing benefit sharing arrangements.
  - b. Project notification and documentation must be presented to the livestock operator in an appropriate format and language to ensure understanding.
3. Labor and Safety: The project developer must attest that the project is in material compliance with all applicable laws, including labor or safety laws. See Section 3.6 Regulatory Compliance for further information.
4. Dispute Resolution: The Reserve holds a 30-day public comment period on all listed projects prior to registration and has an ongoing dispute resolution process. See the Reserve Offset Program Manual and website for further information on programmatic and project specific public consultation and dispute resolution processes. Projects that receive material complaints will not be registered until a satisfactory dispute resolution plan has been approved.

The environmental safeguards requirements include:

1. Air and Water Quality: The project developer must attest that the project is in material compliance with all applicable laws, including environmental regulations (e.g., air and water quality). See Section 3.6 Regulatory Compliance and Appendix A Associated Environmental Impacts for further information.

---

<sup>17</sup> Livestock Operators refers to the entity that owns/operates the livestock facility.

2. **Mitigation of Pollutants:** Projects must be designed and implemented to mitigate potential releases of pollutants that may cause degradation of the quality of soil, air, surface and groundwater such as those described in Appendix A, and project developers must acquire the appropriate local permits prior to installation to prevent violation of all applicable laws.
3. **Animal Welfare:** The project developer must attest that the project is in material compliance with all applicable laws, including those related to the treatment and wellbeing of livestock. See Section 3.6 Regulatory Compliance for further information.

## 4 The GHG Assessment Boundary

The GHG Assessment Boundary delineates the GHG sources, sinks and reservoirs (SSRs) that shall be assessed by project developers to determine the net change in emissions associated with installing a biogas control system. This protocol's assessment boundary captures sources from waste production to disposal, including off-site manure disposal. However, the calculation procedure only incorporates methane and carbon dioxide, so while nitrous oxide sources are technically within the boundary they are not assessed in the calculation procedure. See Box 4.1 for additional information.

This Protocol does not account for carbon dioxide emission reductions associated with displacing grid-delivered electricity or fossil fuel use.

CO<sub>2</sub> emissions associated with the generation and destruction of biogas are considered biogenic emissions<sup>18,19</sup> (as opposed to anthropogenic) and are not included in the GHG Assessment Boundary.

Figure 4.1. provides a general illustration of the GHG Assessment Boundary, which indicates which SSRs are included or excluded from the boundary. All SSRs within the dashed line are accounted for under this Protocol.

Table 4.1 provides greater detail on each SSR and provides justification for the inclusion or exclusion of SSRs and gases from the GHG Assessment Boundary.

---

<sup>18</sup> The rationale is that carbon dioxide emitted during combustion represents the carbon dioxide that would have been emitted during natural decomposition of the manure. Emissions from the biogas control system do not yield a net increase in atmospheric carbon dioxide because they are theoretically equivalent to the carbon dioxide absorbed during plant/feed growth.

<sup>19</sup> The Reserve recommends that livestock operations upgrading biogas for low-carbon fuels, pipeline injection, or electricity conduct biogenic testing to ensure that the content of the biogas is sufficient for its end use; however, it is not a requirement for the carbon project under this protocol.

**Box 4.1. The Reserve's Treatment of Nitrous Oxide Emissions**

This protocol's GHG Assessment Boundary conceptually encompasses sources of nitrous oxide emissions in the waste production, waste treatment and storage, and waste disposal source categories. However, project developers do not calculate nitrous oxide impacts. This determination is made for the sake of "conservativeness" since the high levels of uncertainty associated with the methods to assess nitrous oxide production could lead to overestimations of project reductions.

Procedures to calculate nitrous oxide emissions associated with a livestock operation's manure management system and from the application of manure to soils (both direct and indirect) rely on emission factors with at least an uncertainty range of a factor of two – either 100% above or 50% below the default value.<sup>20</sup> The reason for the large uncertainty is the complex emissions pathway from organic nitrogen in livestock waste to nitrous oxide – the nitrification-denitrification cycle.<sup>21</sup>

As the state of science advances and methods to calculate nitrous oxide emissions at the farm-level improve, the Registry will incorporate them into this protocol. In fact, as the assessment boundary includes sources from waste production to disposal it is set-up to integrate nitrous oxide calculations. The Registry will work with project developers and the research community to develop an appropriate "conservatism factor" that could sufficiently mitigate possible overestimations of project reductions that stem from uncertainty in nitrous oxide quantification.

The CDM "Consolidated baseline methodology for GHG emission reductions from manure management systems" (ACM0010 V.5) allows project developers to calculate decreases in nitrous oxide emissions from sources up to, but excluding, land application.

---

<sup>20</sup> See IPCC 2006 Guidelines volume 4, chapter 10, table 10.21 and volume 4, chapter 11, table 11.3.

<sup>21</sup> Uncertainty also exists with estimations of baseline methane emission. The Reserve takes steps to reduce this uncertainty by following a calculation approach that is based on the monthly biological performance of the operation's anaerobic manure handling systems that existed pre-project, as predicted by the van't Hoff-Arrhenius equation using site-specific data on temperature, Volatile Solids (VS) loading, and system VS retention time. The Reserve has been working to evaluate project-level uncertainty. This work is ongoing, but early results suggest that uncertainty levels associated with the quantification of nitrous oxide are more substantial than methane.

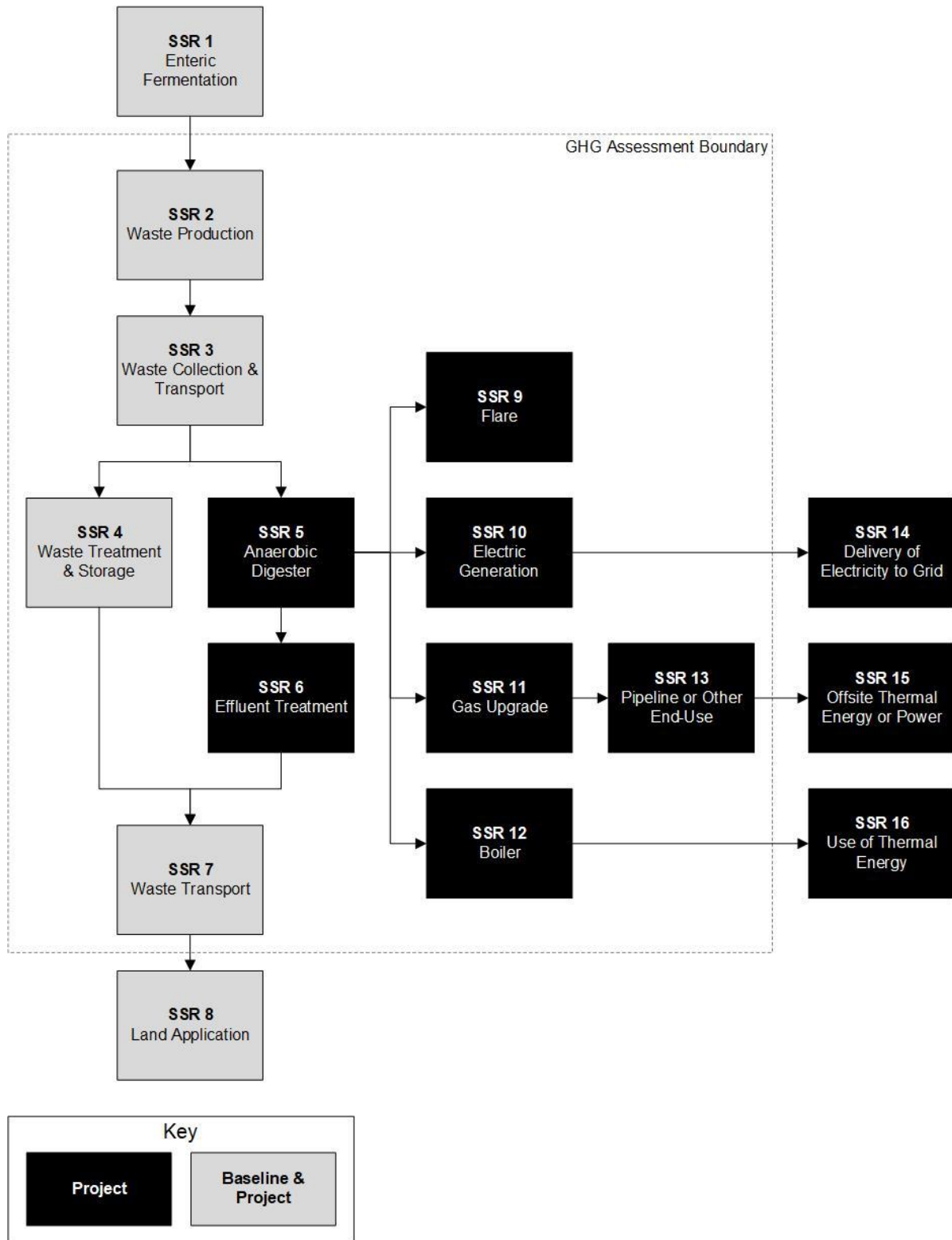

Figure 4.1. General Illustration of the GHG Assessment Boundary

Table 4.1 relates GHG source categories to the appropriate sources and gases, and indicates inclusion in the calculation methodology. It is intended to be illustrative – GHG sources are indicative for the source category, GHGs in addition to the main GHG are also mentioned, where appropriate.

**Table 4.1.** Description of all Sources, Sinks, and Reservoirs

SSR	GHG Source	Gas	Relevant to Baseline (B) or Project (P)	Included/ Excluded	Justification/Explanation
1	Emissions from enteric fermentation	CH <sub>4</sub>	B, P	<i>Excluded</i>	It is very unlikely that a livestock operator would change its feeding strategy to maximize biogas production from a digester; thus impacting enteric fermentation emissions from ruminant animals.
2	Emissions from waste deposits in barn, milking parlor, or pasture/corral	N <sub>2</sub> O	B, P	<i>Excluded</i>	See Box 4.1.
	Emissions from mobile and stationary support equipment	CO <sub>2</sub>	B, P	<i>Included</i>	If any additional vehicles or equipment are required by the project beyond what is required in the baseline, emissions from such sources shall be accounted for.
		CH <sub>4</sub>		<i>Excluded</i>	Emission source is assumed to be very small.
N <sub>2</sub> O	<i>Excluded</i>	Emission source is assumed to be very small.			
3	Emissions from mechanical systems used to collect and transport waste (e.g., engines and pumps for flush systems; vacuums and tractors for scrape systems)	CO <sub>2</sub>	B, P	<i>Included</i>	If any additional vehicles or equipment are required by the project beyond what is required in the baseline, emissions from such sources shall be accounted for.
		CH <sub>4</sub>		<i>Excluded</i>	Emission source is assumed to be very small.
		N <sub>2</sub> O		<i>Excluded</i>	Emission source is assumed to be very small.
	Vehicle emissions (e.g., for centralized digesters)	CO <sub>2</sub>		<i>Included</i>	If any additional vehicles or fuel use is required by the project beyond what is required in the baseline, emissions from such equipment shall be accounted for.
		CH <sub>4</sub>		<i>Excluded</i>	Emission source is assumed to be very small.

SSR	GHG Source	Gas	Relevant to Baseline (B) or Project (P)	Included/ Excluded	Justification/Explanation
		N <sub>2</sub> O		<i>Excluded</i>	Emission source is assumed to be very small.
4	Emissions from waste treatment and storage including: anaerobic lagoons, dry lot deposits, compost piles, solid storage piles, manure settling basins, aerobic treatment, storage ponds, etc.	CO <sub>2</sub>	B, P	<i>Excluded</i>	Biogenic emissions are excluded.
		CH <sub>4</sub>		<i>Included</i>	Primary source of emissions in the baseline.
		N <sub>2</sub> O		<i>Excluded</i>	See Box 4.1.
	Emissions from support equipment	CO <sub>2</sub>		<i>Included</i>	If any additional equipment is required by the project beyond what is required in the baseline, emissions from such equipment shall be accounted for.
		CH <sub>4</sub>		<i>Excluded</i>	Emission source is assumed to be very small.
		N <sub>2</sub> O		<i>Excluded</i>	Emission source is assumed to be very small.
5	Emissions from the anaerobic digester due to biogas collection inefficiencies and venting events	CH <sub>4</sub>	P	<i>Included</i>	Project may result in leaked emissions from anaerobic digester.
6	Emissions from the effluent pond	CH <sub>4</sub>	P	<i>Included</i>	Primary source of emissions from project activities.
		N <sub>2</sub> O		<i>Excluded</i>	See Box 4.1.
7	Vehicle emissions for land application and/or off-site transport	CO <sub>2</sub>	B, P	<i>Included</i>	If any additional vehicle use is required by the project beyond what is required in the baseline, associated additional emissions shall be accounted for.
		CH <sub>4</sub>		<i>Excluded</i>	Emission source is assumed to be very small.
		N <sub>2</sub> O		<i>Excluded</i>	Emission source is assumed to be very small.
8	Emissions from land application	CH <sub>4</sub>	B, P	<i>Excluded</i>	Project activity is unlikely to increase emissions relative to baseline activity.



SSR	GHG Source	Gas	Relevant to Baseline (B) or Project (P)	Included/ Excluded	Justification/Explanation
		N <sub>2</sub> O		<i>Excluded</i>	See Box 4.1.
9	Emissions from combustion during flaring, including emissions from incomplete combustion of biogas	CO <sub>2</sub>	P	<i>Excluded</i>	Biogenic emissions are excluded.
		CH <sub>4</sub>		<i>Included</i>	Primary source of emissions from project activities.
		N <sub>2</sub> O		<i>Excluded</i>	Emission source is assumed to be very small.
10	Emissions from combustion during electric generation, including incomplete combustion of biogas	CO <sub>2</sub>	P	<i>Excluded</i>	Biogenic emissions are excluded.
		CH <sub>4</sub>		<i>Included</i>	Primary source of emissions from project activities.
		N <sub>2</sub> O		<i>Excluded</i>	Emission source is assumed to be very small.
11	Emissions from upgrading biogas for pipeline injection or use as CNG/LNG fuel	CO <sub>2</sub>	P	<i>Included</i>	Emissions resulting from on-site fossil fuel use and/or grid electricity may be significant.
		CH <sub>4</sub>		<i>Excluded</i>	Emission source is assumed to be very small.
		N <sub>2</sub> O		<i>Excluded</i>	Emission source is assumed to be very small.
12	Emissions from combustion at boiler, including emissions from incomplete combustion of biogas	CO <sub>2</sub>	P	<i>Excluded</i>	Biogenic emissions are excluded.
		CH <sub>4</sub>		<i>Included</i>	Primary source of emissions from project activities.
		N <sub>2</sub> O		<i>Excluded</i>	Emission source is assumed to be very small.
13	Emissions from combustion of biogas by end user of pipeline or CNG/LNG, including incomplete combustion	CO <sub>2</sub>	P	<i>Excluded</i>	Biogenic emissions are excluded.
		CH <sub>4</sub>		<i>Included</i>	Primary source of emissions from project activities.
		N <sub>2</sub> O		<i>Excluded</i>	Emission source is assumed to be very small.
14	Delivery and use of project electricity to grid	CO <sub>2</sub>	P	<i>Excluded</i>	This protocol does not cover displacement of GHG emissions from the use of biogas-generated electricity.
		CH <sub>4</sub>			
		N <sub>2</sub> O			
15	Off-site thermal energy or power	CO <sub>2</sub>	P	<i>Excluded</i>	This protocol does not cover displacement of GHG emissions from the use of biogas delivered through pipeline or other end uses.
		CH <sub>4</sub>			
		N <sub>2</sub> O			
16		CO <sub>2</sub>	P	<i>Excluded</i>	

SSR	GHG Source	Gas	Relevant to Baseline (B) or Project (P)	Included/ Excluded	Justification/Explanation
	Use of project-generated thermal energy	CH <sub>4</sub>			This protocol does not cover displacement of GHG emissions from the use of biogas-generated thermal energy.
		N <sub>2</sub> O			
	Project construction and decommissioning emissions	CO <sub>2</sub>	P	<i>Excluded</i>	Emission source is assumed to be very small.
		CH <sub>4</sub>			
		N <sub>2</sub> O			

## 5 Quantifying GHG Emission Reductions

GHG emission reductions from a livestock project are quantified by comparing actual project emissions to baseline emissions at the project site. Baseline emissions are an estimate of the GHG emissions from sources within the GHG Assessment Boundary (see Section 4) that would have occurred in the absence of the livestock project. Project emissions are actual GHG emissions that occur at sources within the GHG Assessment Boundary. Project emissions must be subtracted from the baseline emissions to quantify the project's total net GHG emission reductions (Equation 5.1).

GHG emission reductions are generally quantified and verified on an annual basis. Project developers may choose to quantify and verify GHG emission reductions on a more frequent or less frequent basis if they desire (see Section 7.3). The length of time over which GHG emission reductions are quantified and verified is called the "reporting period." The length of time over which GHG reductions are verified is called a "verification period." A verification period may cover multiple reporting periods (see Section 7.3.4). Project developers should take note that some equations to calculate baseline and project emissions are run on a month-by-month basis and activity data monitoring have varying levels of frequency. As applicable, monthly emissions data (for baseline and project) are summed together to calculate emission reductions.

The calculations provided in this protocol are derived from internationally accepted methodologies.<sup>22</sup> Project developers shall use the calculation methods provided in this protocol to determine baseline and project GHG emissions in order to quantify GHG emission reductions.

To support project developers and facilitate consistent and complete emissions reporting, the Reserve has developed an Excel based calculation tool. Instructions for obtaining the most recent version of this tool are available on the Argentina Livestock Protocol Webpage. The Reserve *recommends* the use of the Argentina Livestock Calculation Tool for all project calculations and emission reduction reports.<sup>23</sup> Only the most recent version of this tool should be used, unless otherwise recommended by Reserve staff. In any case where there is potential disagreement between guidance provided in the protocol and guidance provided in the calculation tool, the protocol shall take precedent.

The current methodology for quantifying the GHG impact associated with installing a biogas control system requires the use of both modeled reductions (following Equation 5.2 to Equation 5.4 and Equation 5.6 to Equation 5.9) as well as the utilization of *ex-post* metered data from the biogas control system to be used as a check on the modeled reductions.

The Reserve recognizes that there can be material differences between modeled methane emission reductions and the actual metered quantity of methane that is captured and destroyed by the biogas control system due to digester start-up periods, venting events, and other biogas control system operational issues. These operational issues have the potential to result in

---

<sup>22</sup> The Reserve's GHG reduction calculation method is derived from the Kyoto Protocol's Clean Development Mechanism (ACM0010 V.5), the EPA's Climate Leaders Program (Manure Offset Protocol, August 2008), and the RGGI Model Rule (January 5, 2007).

<sup>23</sup> There are tools in other countries that are useful in supporting swine operations for estimating biogas production. However, actual GHG reductions should be calculated in accordance with the guidance of this Protocol.

substantially less methane destruction than is modeled, leading to an overestimation of GHG reductions in the modeled case.

To address this issue and maintain consistency with international best practice, the Reserve requires the modeled methane emission reduction results to be compared to the *ex-post* metered quantity of methane that is captured and destroyed by the biogas control system. The lesser of the two values will represent the total methane emission reductions for the reporting period. Equation 5.1 outlines the quantification approach for calculating the emission reductions from the installation of a biogas control system.<sup>24</sup>

## 5.1 Required Parameters for Modeling Baseline and Project Emissions

The following parameters must be determined for the modeling of baseline and project emissions:

### Population – $P_L$

The procedure requires project developers to differentiate between livestock categories ('L') – e.g., lactating dairy cows, non-milking dairy cows, heifers, etc. This accounts for differences in methane generation across livestock categories. See Appendix B, Table B.2. The population of each livestock category is monitored on a monthly basis, and for Equation 5.4 averaged for an annual total population.

### Volatile Solids – $VS_L$

This value represents the daily organic material in the manure for each livestock category and consists of both biodegradable and non-biodegradable fractions. The VS content of manure is a combination of excreted fecal material (the fraction of a livestock category's diet consumed and not digested) and urinary excretions, expressed in a dry matter weight basis (kg/animal).<sup>25</sup> This protocol requires that the VS value for all livestock categories be determined as outlined in Box 5.1.

### Mass<sub>L</sub>

This value is the annual average weight of the animals, per livestock category. Site specific livestock mass is preferred for all livestock categories. If site-specific data is unavailable, Typical Average Mass (TAM) values can be used (Appendix B, Table B.2).

### Maximum Methane Production – $B_{0,L}$

This value represents the maximum methane-producing capacity of the manure, differentiated by livestock category ('L') and diet. Project developers shall use the default  $B_0$  factors from Appendix B, Table B.3. Alternatively, project developers may follow the sampling and testing

---

<sup>24</sup> The calculation procedure only addresses direct emissions sources and does not incorporate changes in electricity consumption, which impacts indirect emissions associated with power plants owned and operated by entities other than the livestock operator.

<sup>25</sup> IPCC 2006 Guidelines volume 4, chapter 10, p. 10.42.

procedure contained in Section 6.1 in order to determine a site-specific  $B_0$  value for a particular animal category.

## MS

The MS value apportions manure from each livestock category to appropriate manure management system component ('S'). It reflects the reality that waste from the operation's livestock categories are not managed uniformly. The MS value accounts for the operation's multiple types of manure management systems. It is expressed as a percentage (%), relative to the total amount of waste produced by the livestock category. As waste production is normalized for each livestock category, the percentage should be calculated as percent of population for each livestock category. For example, a dairy operation might send 85% of its milking cows waste to an anaerobic lagoon and 15% could be deposited in a corral. In this situation an MS value of 85% would be assigned to Equation 5.3 and 15% to Equation 5.4.

Importantly, the MS value indicates where the waste would have been managed in the baseline scenario.

## Methane Conversion Factor – MCF

Each manure management system component has a volatile solids-to-methane conversion efficiency, which represents the degree to which maximum methane production ( $B_0$ ) is achieved. Methane production is a function of the extent of anaerobic conditions present in the system, the temperature of the system, and the retention time of organic material in the system.<sup>26</sup>

According to this protocol, for anaerobic lagoons, storage ponds, liquid slurry tanks etc., project developers perform a site-specific calculation of the mass of volatile solids degraded by the anaerobic storage/treatment system. This is expressed as “degraded volatile solids” or “ $VS_{deg}$ ” in Equation 5.3, which equals the system's monthly available volatile solids multiplied by the van't Hoff-Arrhenius ( $f$ ) factor. The ' $f$ ' factor effectively converts total available volatile solids in the anaerobic manure storage/treatment system to methane-convertible volatile solids, based on the monthly temperature of the system.

The multiplication of “ $VS_{deg}$ ” by “ $B_0$ ” gives a site-specific quantification of the uncontrolled methane emissions that would have occurred in the absence of a digester – from the anaerobic storage and/or treatment system, taking into account each livestock category's contribution of manure to that system.

This method to calculate methane emissions reflects the site-specific monthly biological performance of the operation's anaerobic manure handling systems that existed pre-project, as predicted by the van't Hoff-Arrhenius equation using farm-level data on temperature, VS loading, and system VS retention time.<sup>27</sup>

Default MCF values for non-anaerobic manure storage/treatment should be chosen based on the climate zone for the project location. Default MCF values are available in Appendix B, Table B.4, which are used for Equation 5.4.

---

<sup>26</sup> IPCC 2006 Guidelines volume 4, chapter 10, p. 10.43.

<sup>27</sup> The method is derived from Mangino et al., “Development of a Methane Conversion Factor to Estimate Emissions from Animal Waste Lagoons”

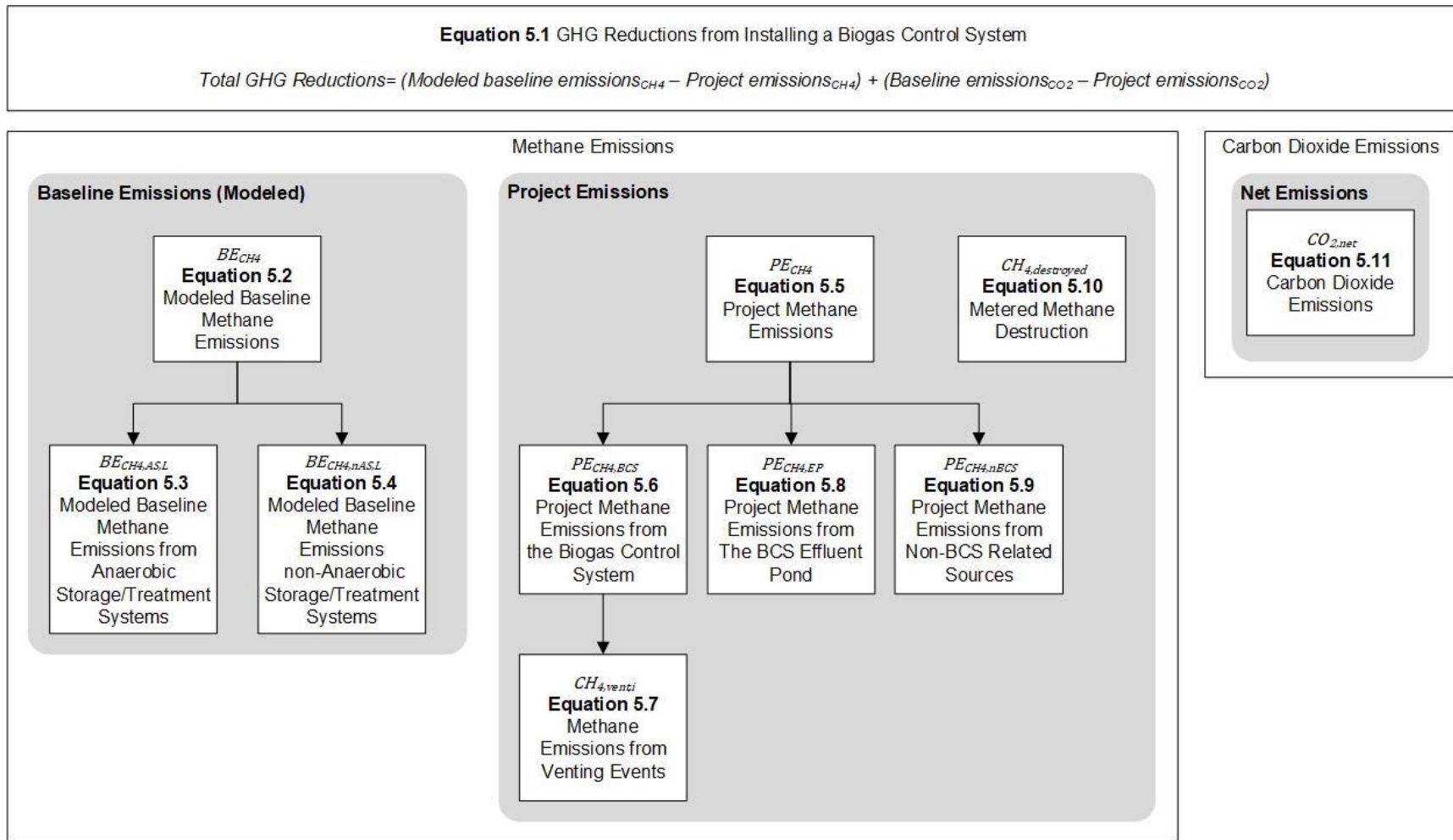

**Figure 5.1.** Organizational Chart for Equations in Section 5

**Equation 5.1. GHG Reductions from Installing a Biogas Control System**

$$\begin{aligned} \text{Total GHG Reductions} = & \quad (\text{Modeled baseline emissions}_{CH_4} - \text{Project emissions}_{CH_4}) \\ & + (\text{Baseline emissions}_{CO_2} - \text{Project emissions}_{CO_2}) \end{aligned}$$

The  $(\text{Modeled baseline emissions}_{CH_4} - \text{Project emissions}_{CH_4})$  term shall be calculated according to Equation 5.2 to Equation 5.4 and Equation 5.6 to Equation 5.9. The resulting aggregated quantity of methane reductions must then be compared to the *ex-post* quantity of methane that is metered and destroyed in the biogas collection system, as expressed in Equation 5.10. In the case that the total *ex-post* quantity of metered and destroyed methane is less than the modeled methane reductions, the metered quantity of destroyed methane will replace the modeled methane reductions.

Therefore, the above equation then becomes:

$$\begin{aligned} \text{Total GHG Reductions} = & \quad (\text{Total quantity of metered and destroyed methane}) \\ & + (\text{Baseline emissions}_{CO_2} - \text{Project emissions}_{CO_2}) \end{aligned}$$

**5.2 Modeling Baseline Methane Emissions**

Baseline emissions represent the GHG emissions within the GHG Assessment Boundary that would have occurred if not for the installation of the biogas control system.<sup>28</sup> For the purposes of this Protocol, project developers calculate their baseline emissions according to the manure management system in place prior to installing the biogas control system. This is referred to as a “continuation of current practices” baseline scenario. Additionally, project developers calculate baseline emissions each year of the project.<sup>29</sup> The procedure assumes there is no biogas control system in the baseline system. Regarding new livestock operations that install a biogas control system, project developers establish a modeled baseline scenario using the prevailing system type in use for the geographic area, animal type, and farm size that corresponds to their operation.

The procedure to determine the modeled baseline methane emissions follows Equation 5.2, which combines Equation 5.3 and Equation 5.4.

Equation 5.3 calculates methane emissions from anaerobic manure storage/treatment systems based on site-specific information on the mass of volatile solids degraded by the anaerobic storage/treatment system and available for methane conversion.<sup>30</sup> Equation 5.3 incorporates the effects of temperature through the van't Hoff-Arrhenius ( $f$ ) factor and accounts for the retention of volatile solids through the use of monthly assessments. Equation 5.4 is less intensive and applies to non-anaerobic storage/treatment systems. Both Equation 5.3 and Equation 5.4 reflect basic biological principles of methane production from available volatile solids, determine

<sup>28</sup> Emissions from anaerobic systems such as open lagoons or final disposal sites in the case of solid waste.

<sup>29</sup> Conversely, under a “static baseline,” a project developer would assess baseline emissions once before project implementation and use that value throughout the project lifetime.

<sup>30</sup> Anaerobic storage/treatment systems generally refer to anaerobic lagoons, or storage ponds, etc.

methane generation for each livestock category, and account for the extent to which the waste management system handles each category's manure.

**Equation 5.2. Modeled Baseline Methane Emissions**

$$BE_{CH_4} = \sum_{S,L} BE_{CH_4,AS,L} + BE_{CH_4,non-AS,L}$$

Where,		Units
$BE_{CH_4}$	= Total annual baseline methane emissions, expressed in carbon dioxide equivalent	tCO <sub>2</sub> e/yr
$BE_{CH_4,AS,L}$	= Total annual baseline methane emissions from anaerobic storage/treatment systems by livestock category 'L', expressed in carbon dioxide equivalent	tCO <sub>2</sub> e/yr
$BE_{CH_4,non-AS,L}$	= Total annual baseline methane emissions from non-anaerobic storage/treatment systems, expressed in carbon dioxide equivalent	tCO <sub>2</sub> e/yr

**Equation 5.3. Modeled Baseline Methane Emissions from Anaerobic Storage/Treatment Systems**

$$BE_{CH_4,AS,L} = \sum_{L,AS} VS_{deg,AS,L} \times B_{0,L} \times 0.717 \times 0.001 \times GWP$$

Where,		Units
$BE_{CH_4,AS}$	= Total annual baseline methane emissions from anaerobic manure storage/treatment systems, expressed in carbon dioxide equivalent	tCO <sub>2</sub> e/yr
$VS_{deg,AS,L}$	= Annual volatile solids degraded in anaerobic manure storage/treatment system 'AS' from livestock category 'L'	kg dry matter
$B_{0,L}$	= Maximum methane producing capacity of manure for livestock category 'L' – Site specific values <sup>31</sup> or default values (Appendix B, Table B.3)	m <sup>3</sup> CH <sub>4</sub> /kg of VS

<sup>31</sup> B<sub>0</sub> for dairy cattle may be determined using site-specific data from the sampling and analysis methodology as defined in Section 6.1. However, default B<sub>0</sub> values are required for swine, and beef cattle,. See Appendix E for the development of the B<sub>0</sub> sampling and analysis methodology.



**Equation 5.3.** Continued

0.717	=	Methane density conversion factor, m <sup>3</sup> to kg (at 0°C and 1 atm pressure) <sup>32</sup>	
0.001	=	Conversion factor from kg to metric tons	
GWP	=	Global Warming Potential factor of methane to carbon dioxide equivalent <sup>33</sup>	
$VS_{deg,AS,L} = \sum_{AS,L} VS_{avail,AS,L} \times f$			
<i>Where,</i>			<u>Units</u>
VS <sub>deg,AS,L</sub>	=	Annual volatile solids degraded by anaerobic manure storage/treatment system 'AS' by livestock category 'L'	kg dry matter
VS <sub>avail,AS,L</sub>	=	Monthly volatile solids available for degradation from anaerobic manure storage/treatment system 'AS' by livestock category 'L'	kg dry matter
<i>f</i>	=	The van't Hoff-Arrhenius factor: "the proportion of volatile solids that are biologically available for conversion to methane based on the monthly temperature of the system" <sup>34</sup>	
$VS_{avail,AS,L} = (VS_L \times P_L \times MS_{AS,L} \times dpm \times 0.8) + (VS_{avail-1,AS} - VS_{deg-1,AS})$			
<i>Where,</i>			<u>Units</u>
VS <sub>avail,AS,L</sub>	=	Monthly volatile solids available for degradation in anaerobic storage/treatment system 'AS' by livestock category 'L'	kg dry matter
VS <sub>L</sub>	=	Volatile solids produced by livestock category 'L' on a dry matter basis. <i>Important:</i> refer to Box 5.1 for guidance on using appropriate units for VS <sub>L</sub> values from Appendix B	kg/animal/day
P <sub>L</sub>	=	Annual average population of livestock category 'L' (based on monthly population data)	

<sup>32</sup> These standard conditions refer to the International Union of Pure and Applied Technology (IUAPC). Methane density at the standard conditions of the National Institute of Standards and Technology (NIST), 20°C and 1 atm is 0.668 kg CH<sub>4</sub>/m<sup>3</sup>.

<sup>33</sup> Refer to section 2.6.1 in the Reserve Offset Program Manual and any policy memos for the most recent GWP value.

<sup>34</sup> Mangino et al.

**Equation 5.3.** Continued

$MS_{AS,L}$	=	Percent of manure sent to (managed in) anaerobic manure storage/treatment system 'AS' from livestock category 'L' <sup>35</sup>	%
dpm	=	Days per month	days
0.8	=	System calibration factor <sup>36</sup>	
$VS_{avail-1,AS}$	=	Previous month's volatile solids available for degradation in anaerobic system 'AS'	kg
$VS_{deg-1,AS}$	=	Previous month's volatile solids degraded by anaerobic system 'AS' <sup>37</sup>	kg
$f = exp \left[ \frac{E(T_2 - T_1)}{RT_1T_2} \right]$			
<i>Where,</i>			<u>Units</u>
$f$	=	The van't Hoff-Arrhenius factor	
$E$	=	Activation energy constant (15,175)	cal/mol
$T_1$	=	303.16	K
$T_2$	=	Monthly average ambient temperature (K = °C + 273). If $T_2 < 5^\circ\text{C}$ then $f = 0.104$ or if $T_2 > 29.5^\circ\text{C}$ then $f = 0.95$	K
$R$	=	Ideal gas constant (1.987)	cal/Kmol

<sup>35</sup> The MS value represents the percent of manure that would be sent to (managed by) the anaerobic manure storage/treatment systems in the baseline case – as if the biogas control system was never installed.

<sup>36</sup> Mangino, et al. This factor was derived to “account for management and design practices that result in the loss of volatile solids from the management system.”

<sup>37</sup> The difference between  $VS_{avail-1}$  and  $VS_{deg-1}$  represents VS retained in the system and not removed at month's end; thus VS could accumulate over time. However, project developers should not carry-over volatile solids from one month to the next after a system has been cleaned out, such as temporary storage ponds or tanks where the VS-retention time might be 30 days. For these systems project developers do not add “( $VS_{avail-1} - VS_{deg-1}$ ).”

**Equation 5.4.** Modeled Baseline Methane for Non-Anaerobic Storage/Treatment Systems

$BE_{CH_4,nAS} = \left( \sum_{L,S} P_L \times MS_{L,nAS} \times VS_L \times 365 \times MCF_{nAS} \times B_{0,L} \right) \times 0.717 \times 0.001 \times GWP$		
<i>Where,</i>		<u>Units</u>
$BE_{CH_4,nAS}$	= Total annual baseline methane emissions from non-anaerobic storage/treatment systems, expressed in carbon dioxide equivalent	tCO <sub>2</sub> e/yr
$P_L$	= Annual average population of livestock category 'L' (based on monthly population data)	
$MS_{L,nAS}$	= Percent of manure from livestock category 'L' managed in non-anaerobic storage/treatment systems	%
$VS_L$	= Volatile solids produced by livestock category 'L' on a dry matter basis. <i>Important:</i> refer to Box 5.1 for guidance on using appropriate units for $VS_L$ values from Appendix B	kg/animal/ day
365	= Days in a year	days
$MCF_{nAS}$	= Methane conversion factor for non-anaerobic storage/treatment system 'AS' – Appendix B, Table B.4	%
$B_{0,L}$	= Maximum methane producing capacity for manure for livestock category 'L' – Site specific value or default factor (see Appendix B, Table B.3)	m <sup>3</sup> CH <sub>4</sub> /kg of VS dry matter
0.717	= Methane density conversion factor, m <sup>3</sup> to kg (at 0°C and 1 atm pressure)	
0.001	= Conversion factor from kg to metric tons	
GWP	= Global Warming Potential factor of methane to carbon dioxide equivalent	

**Box 5.1. Daily Volatile Solids for All Livestock Categories**

VS<sub>L</sub> values for all livestock can be found in Appendix B, Table B.3.

*Important:* Units provided for all VS values in Appendix B are based on specific values for Argentina and default values from the IPCC guidelines. According to the CDM methodology ACM0010, it is recommended to adjust the VS values according to site-specific animal mass data, using the following equation:

$$VS_L = VS_{table} \times \left( \frac{Mass_L}{MTP_L} \right)$$

<i>Where,</i>	<u>Units</u>
VS <sub>L</sub> = Volatile solid excretion on a dry matter weight basis	kg/animal/day
VS <sub>table</sub> = Volatile solid excretion from lookup Table B.3	kg/animal/day
Mass <sub>L</sub> = Average animal mass for livestock category 'L'. If site specific data is unavailable, use values from Appendix B, Table B.2	kg
MTP <sub>L</sub> = Average animal mass from lookup Table B.2	kg

### 5.3 Calculating Project Methane Emissions

Project emissions are actual GHG emissions that occur within the GHG Assessment Boundary after the installation of the biogas control system. Project emissions are calculated on an annual, *ex-post* basis. But like baseline emissions, some parameters are monitored on a monthly basis. Methane emissions from manure storage and/or treatment systems other than the digester are modeled much the same as in the baseline scenario.

#### 5.3.1 Modeled Methane Destruction

As shown in Equation 5.5, project methane emissions equal:

- The amount of methane from waste treatment and storage not captured and destroyed by the control system, plus
- Methane from the digester effluent storage pond (if necessary), plus
- Methane from sources in the waste treatment and storage category other than the biogas control system and associated effluent pond. This includes all other manure treatment systems such as compost piles, solids storage, daily spread, etc.

Consistent with ACM0010 and this protocol's baseline methane calculation approach, the formula to account for project methane emissions incorporates all potential sources within the waste treatment and storage category. Non-biogas control system-related sources follow the

same calculation approach as provided in the baseline methane equations. Several activity data for the variables in Equation 5.9 will be the same as those in Equation 5.2 to Equation 5.4.

Although not common under normal digester operation, it is possible that a venting event may occur due to catastrophic failure of digester cover materials, the digester vessel, or the gas collection system. In the event that a catastrophic system failure results in the venting of biogas, the quantity of methane released to the atmosphere shall be estimated according to Equation 5.7 below.

**Equation 5.5. Project Methane Emissions**

$PE_{CH_4} = [(PE_{CH_4,BCS} + PE_{CH_4,EP} + PE_{CH_4,non-BCS}) \times GWP]$		
<i>Where,</i>		<u>Units</u>
$PE_{CH_4}$	= Total annual project methane emissions, expressed in carbon dioxide equivalent	tCO <sub>2</sub> e/yr
$PE_{CH_4, BCS}$	= Annual methane emissions from the BCS – Equation 5.6	tCH <sub>4</sub> /yr
$PE_{CH_4, EP}$	= Annual methane emissions from the BCS effluent pond – Equation 5.8	tCH <sub>4</sub> /yr
$PE_{CH_4, non-BCS}$	= Annual methane emissions from sources in the waste treatment and storage category other than the BCS and associated effluent pond – Equation 5.9	tCH <sub>4</sub> /yr
$GWP$	= Global Warming Potential factor of methane to carbon dioxide equivalent	

**Equation 5.6. Project Methane Emissions from the Biogas Control System**

$$PE_{CH_4,BCS} = \left[ (CH_{4,meter}) \left( \frac{1}{BCE} - BDE_{i,weighted} \right) \right] + CH_{4,vent,i}$$

Where,

Units

$PE_{CH_4,BCS}$	= Monthly methane emissions from the BCS, to be aggregated annually	tCH <sub>4</sub> /yr
$CH_{4,meter}$	= The monthly quantity of methane collected and metered	tCH <sub>4</sub> /month
BCE	= Monthly methane collection efficiency of the BCS. The default value is 85% <sup>38</sup>	% (as a decimal)
$BDE_{i,weighted}$	= Monthly weighted average of all destruction devices used in month i	% (as a decimal)
$CH_{4,vent,i}$	= The monthly quantity of methane that is vented to the atmosphere due to BCS venting events, as quantified in Equation 5.7 below	

$$CH_{4,meter} = F \times (273.15/T)^* \times (P/1)^* \times CH_{4,conc} \times 0.717 \times 0.001$$

Where,

Units

$CH_{4,meter}$	= The monthly quantity of methane collected and metered <sup>39</sup>	tCH <sub>4</sub> /month
F	= Measured volumetric flow of biogas per month	m <sup>3</sup> /month
T	= Temperature of the biogas flow (K = °C + 273.15)	K
P	= Pressure of the biogas flow	atm
$CH_{4,conc}$	= Measured methane concentration of biogas from the most recent methane concentration measurement	% (as a decimal)
0.717	= Density of methane gas at STP (1 atm, 0°C)	kgCH <sub>4</sub> /m <sup>3</sup>
0.001	= Conversion factor, kg to metric tons	

<sup>38</sup> Project developers have the option to justify a higher BCS collection efficiency based on verifiable documentation.

<sup>39</sup> This value reflects directly measured biogas mass flow and methane concentration in the biogas to the combustion device.

**Equation 5.6.** Continued.

\* The terms (273.15/T) and (P/1), above, should be omitted if the continuous flow meter automatically corrects for temperature and pressure.

$$BDE_{i,weighted} = \frac{\sum_{DD} (BDE_{DD} \times F_{i,DD})}{F_i}$$

Where,

Units

$BDE_{i,weighted}$	= Monthly weighted average of all destruction devices used in month $i$	fraction
$BDE_{DD}$	= Default methane destruction efficiency of a particular destruction device 'DD'. See Appendix B for default destruction efficiencies by destruction device <sup>40</sup>	
$F_{i,DD}$	= Monthly flow of biogas to a particular destruction device 'DD'	$m^3$
$F_i$	= Total monthly measured volumetric flow of biogas to all destruction devices	$m^3$

<sup>40</sup> Project developers have the option of using either the default methane destruction efficiencies provided or the site-specific methane destruction efficiencies as provided by an accredited provincial or local agency providing testing services of origin, for each of the combustion devices used in the project. If neither the province, nor the municipality nor the district relevant to the project site offer an accreditation for proof of origin providers, an accredited service provider from another province or municipality may be chosen. Alternatively, projects may choose a non-accredited service provider, under the following conditions: 1) The service provider must provide verifiable evidence of prior testing that it has been accepted into compliance by a domestic regulatory agency, and 2) the prior testing procedures must be substantially similar to the procedures used to determine the methane destruction efficiency for the project destruction device(s).

**Equation 5.7. Methane Emissions from Venting Events**

$$CH_{4,vent,i} = (MS_{BCS} + (F_{pw} \times t)) \times CH_{4,conc} \times 0.04230 \times 0.000454$$

<i>Where,</i>		<u>Units</u>
$MS_{BCS}$	= Maximum biogas storage of the BCS system <sup>41</sup>	m <sup>3</sup>
$F_{pw}$	= The average total flow of biogas from the digester for the entire week prior to the venting event <sup>41</sup>	m <sup>3</sup> /day
$t$	= The number of days of the month that biogas is venting uncontrolled from the BCS system (can be a fraction)	days
$CH_{4, conc}$	= Measured methane concentration of biogas prior to the venting event	Fraction
0.04230	= Density of methane gas (1 atm, 0°C)	lb CH <sub>4</sub> / m <sup>3</sup>
0.000454	= Conversion factor from lb to metric ton	

<sup>41</sup> If the BCS consists of multiple digester tanks or covered lagoons, the project only need quantify the maximum storage ( $MS_{BCS}$ ) and biogas flow ( $F_{pw}$ ) of the component(s) of the BCS that experienced the venting event.



**Equation 5.8. Project Methane Emissions from the BCS Effluent Pond<sup>42</sup>**

$$PE_{CH_4,EP} = VS_{ep} \times B_{o,ep} \times 365 \times 0.717 \times MCF_{ep} \times 0.001$$

<i>Where,</i>		<u>Units</u>
$PE_{CH_4,EP}$	= Methane emissions from the effluent pond	tCH <sub>4</sub> /year
$VS_{ep}$	= Volatile solid to effluent pond – 30% of the average daily VS entering the digester <sup>43</sup>	kg/day
$B_{o,ep}$	= Maximum methane producing capacity (of VS dry matter) <sup>44</sup>	m <sup>3</sup> CH <sub>4</sub> /kg
365	= Number of days in a year	days
0.717	= Conversion factor for m <sup>3</sup> to kg	
$MCF_{ep}$	= Methane conversion factor	%
0.001	= Conversion factor from kg to metric tons	

<sup>42</sup> If there is no effluent pond and project developers send digester effluent (VS) to compost piles or apply it directly to land, then VS should also be tracked for these cases using Equation 5.9. Methane emissions from land application manure disposal are not included in the evolution of the greenhouse gas limit for livestock projects, nor in the baseline, or project scenario. However, if the effluent is transported off the project site for application elsewhere, the fossil fuels associated with this transport must be quantified as project emissions (Equation 5.11).

<sup>43</sup> According to the ACM0010 methodology.

<sup>44</sup> The  $B_o$  value for the project effluent pond is not differentiated by livestock category. Project developers shall use the  $B_o$  value that corresponds with a weighted average of the operation's livestock categories that contributes manure to the biogas control system. Supporting laboratory data and documentation per Section 6.1, need to be supplied to the verifier to justify the alternative value.

**Equation 5.8.** Continued

$$VS_{ep} = \left( \sum_L (VS_L \times P_L \times MS_{L,BCS}) \right) \times 0.3$$

Where,		Units
$VS_L$	= Volatile solids produced by livestock category 'L' on a dry matter basis. <i>Important:</i> refer to Box 5.1 for guidance on using appropriate units for $VS_L$ values from Appendix B	kg/animal/day
$P_L$	= Annual average population of livestock category 'L' (based on monthly population data)	
$MS_{L,BCS}$	= Percent of manure from livestock category 'L' that is managed in the biogas control system	%
0.3	= Default value representing the amount of VS that exit the digester as a percentage of the VS entering the digester	

If the effluent from the project digester is directed to an open effluent pond, project developers should use the liquid slurry MCF value for uncovered effluent ponds from Appendix B, Table B.4. If the effluent from the project digester is directed to a covered liquid effluent storage system, and the biogas from this storage system is not collected and destroyed, then the following scenarios apply:

1. If the effluent from this system is applied directly to land, the value of  $PECH_{4,EP}$  shall be equal to the quantity of methane released directly from this storage system, divided by the biogas collection efficiency (BCE). The monitoring of biogas flow and methane concentration shall follow the requirements of Section 6. For any periods where biogas data from this system are missing or not in conformance with Section 6, Equation 5.8 shall be used to determine the quantity of methane for those periods, applying a value of 1.0 for  $MCF_{ep}$ .
2. If the effluent from the covered liquid effluent storage system is directed to another treatment system (i.e., not land-applied), the additional methane released from this further treatment must be quantified. The following adapted version of Formula 1 (see Appendix B) shall be applied to determine the MCF value for a covered liquid effluent storage system in this case. Use of this formula requires that the biogas production of the covered liquid effluent storage system be metered. If the biogas from this system is not metered, the value of  $MCF_{ep}$  shall be 1.0. For any periods when biogas from this system is not metered, the value of  $MCF_{ep}$  shall be 1.0, and these periods shall be quantified separately from the formula 1 in Appendix B.

**Equation 5.9.** Project Methane Emissions from *Non-Biogas Control System Related Sources*<sup>45</sup>

$$PE_{CH_4, nBCS} = \left( \sum_L (EF_{CH_4, L} (nBCSs) \times P_L) \right) \times 0.001$$

*Where,*

		<u>Units</u>
$PE_{CH_4, nBCS}$	= Methane from sources in the waste treatment and storage category other than the biogas control system and associated effluent pond	tCH <sub>4</sub> /yr
$EF_{CH_4, L} (nBCSs)$	= Emission factor for the livestock population from non-BCS-related sources (calculated below)	kgCH <sub>4</sub> /head/year
$P_L$	= Population of livestock category 'L'	
0.001	= Conversion factor from kg to metric tons	

$$EF_{CH_4, L} (nBCSs) = (VS_L \times B_{o, L} \times 365 \times 0.717) \times \left( \sum_S (MCF_S \times MS_{L, S}) \right)$$

*Where,*

		<u>Units</u>
$EF_{CH_4, L} (nBCSs)$	= Methane emission factor for the livestock population from non-biogas control system related sources	kgCH <sub>4</sub> /head/year
$VS_L$	= Volatile solids produced by livestock category 'L' on a dry matter basis. <i>Important:</i> refer to Box 5.1 for guidance on using appropriate units for $VS_L$ values from Appendix B	kg/animal/day
$B_{o, L}$	= Maximum methane producing capacity for manure for livestock category 'L' – Appendix B, Table B.3	m <sup>3</sup> CH <sub>4</sub> /kg of VS dry matter
365	= Number of days in a year	days
0.717	= Conversion factor for m <sup>3</sup> to kg	
$MCF_S$	= Methane conversion factor for system component 'S' – Appendix B, Table B.4	%
$MS_{L, S}$	= Percent of manure from livestock category 'L' that is managed in non-BCS system component 'S'	%

<sup>45</sup> According to this protocol, non-BCS-related sources means manure management system components (system component 'S') other than the biogas control system and the BCS effluent pond (if used).

### 5.3.2 Metered Methane Destruction Comparison

As described above, the Reserve requires all projects to compare the modeled methane emission reductions for the reporting period, as calculated in Equation 5.3 to Equation 5.4 and Equation 5.6 to Equation 5.9 above, with the actual metered amount of methane that is destroyed in the biogas control system over the same period. The lesser of the two values is to be used as the total methane emission reductions for the reporting period in question.

In order to calculate the metered methane reductions, the monthly quantity of biogas that is metered and destroyed by the biogas control system must be aggregated over the reporting period. In the event that a project developer is reporting reductions for a period of time that is less than a full year, the total modeled methane emission reductions would be aggregated over this time period and compared with the metered methane that is destroyed in the biogas control system over the same period of time. For example, if a project is reporting and verifying only 6 months of data, July to December for instance, then the modeled emission reductions over this 6-month period would be compared to the total metered biogas destroyed over the same 6-month period, and the lesser of the two values would be used as the total methane emission reduction quantity for this 6-month period.

#### Equation 5.10. Metered Methane Destruction

$CH_{4,destroyed} = \sum_{months} (CH_{4,meter} \times BDE) \times GWP$		
Where,		<u>Units</u>
$CH_{4,destroyed}$	= The aggregated quantity of methane collected and destroyed during the reporting period	tCO <sub>2</sub> e/yr
$CH_{4,meter}$	= The monthly quantity of methane collected and metered. See Equation 5.6 for calculation guidance	tCH <sub>4</sub> /month
$BDE_{i,weighted}$	= Monthly weighted average of all destruction devices used in month i. <sup>46</sup> See Equation 5.6 for calculation guidance	% (as a decimal)
GWP	= Global Warming Potential factor of methane to carbon dioxide equivalent	

### 5.3.3 Determining Methane Emission Reductions

If metered methane destruction ( $CH_{4,destroyed}$ ) is less than modeled methane destruction ( $BE_{CH_4} - PE_{CH_4}$ ) as calculated in Equation 5.2 to Equation 5.4 and Equation 5.6 to Equation 5.9 for the reporting period, then the methane emission reductions are equal to  $CH_{4,destroyed}$ . Otherwise, the methane emission reductions are equal to  $(BE_{CH_4} - PE_{CH_4})$ .

<sup>46</sup> Project developers have the option to use either the default methane destruction efficiencies provided, or site-specific methane destruction efficiencies as provided by a provincial or local agency accredited source test service provider, for each of the combustion devices used in the project.

## 5.4 Calculating Baseline and Project Carbon Dioxide Emissions

Sources of carbon dioxide emissions associated with a project may include electricity use by pumps and equipment, fossil fuel generators used to power pumping systems or milking parlor equipment, tractors that operate in barns or freestalls, on-site manure hauling trucks, or vehicles that transport manure off-site. Per Table 4.1, the carbon dioxide emissions from any additional equipment, vehicles, or fuel use that is required by the project beyond what is required in the baseline shall be accounted for. In practice, project developers shall account for the emissions from any new electric- or fuel-powered equipment or vehicles purchased and installed/operated specifically for the purpose of implementing the project, as well as any additional fuel used by old or new vehicles to collect or transport waste.

Project developers may either use Equation 5.11 below to calculate the net change in carbon dioxide emissions, or, if they can demonstrate during verification that project carbon dioxide emissions are estimated to be equal to or less than 5% of the total baseline emissions, then the project developer may estimate baseline and project carbon dioxide emissions. If an estimation method is used, verifiers shall confirm based on professional judgment that project carbon dioxide emissions are equal to or less than 5% of the total baseline emissions based on documentation and the estimation methodology provided by the project developer. If emissions cannot be confirmed to be below 5%, then Equation 5.11 shall be used. Regardless of the method used, all estimates or calculations of anthropogenic carbon dioxide emissions within the GHG Assessment Boundary must be verified and included in emission reduction calculations.<sup>47</sup>

If calculations or estimates indicate that the project results in a net decrease in carbon dioxide emissions from grid-delivered electricity, mobile and stationary sources, then for quantification purposes the net change in these emissions must be specified as zero (i.e.,  $CO_{2,net} = 0$  in Equation 5.11).

Equation 5.11 below calculates the net change in anthropogenic carbon dioxide emissions resulting from the project activity.

---

<sup>47</sup> This is consistent with guidance in WRI's GHG Project Protocol regarding the treatment of significant secondary effects.

**Equation 5.11. Carbon Dioxide Emission Calculations**

$$CO_{2,net} = (BE_{CO_2MSC} - PE_{CO_2MSC})$$

Where,

Units

$CO_{2,net}$  = Net change in anthropogenic carbon dioxide emissions from electricity consumption and mobile and stationary combustion sources resulting from project activity tCO<sub>2</sub>/yr

$BE_{CO_2MSC}$  = Total annual baseline carbon dioxide emissions from electricity consumption and mobile and stationary combustion sources (see equation below) tCO<sub>2</sub>/yr

$PE_{CO_2MSC}$  = Total annual project carbon dioxide emissions from electricity consumption and mobile and stationary combustion sources (see equation below) tCO<sub>2</sub>/yr

All electricity consumption and stationary and mobile combustion are calculated using the equation:

$$CO_{2,MSC} = \left( \sum_c QE_c \times EF_{CO_2,e} \right) + \left[ \left( \sum_c QF_c \times EF_{CO_2,f} \right) \times 0.001 \right]$$

Where,

Units

$CO_{2, MSC}$  = Anthropogenic carbon dioxide emissions from electricity consumption and mobile and stationary combustion sources tCO<sub>2</sub>

$QE_c^*$  = Quantity of electricity consumed for each emission source 'c' MWh/yr

$EF_{CO_2,e}$  = CO<sub>2</sub> emission factor 'e' for electricity used<sup>48</sup> tCO<sub>2</sub>/MWh

$EF_{CO_2,f}$  = Fuel-specific emission factor 'f' – Appendix B, Table B.5 kg CO<sub>2</sub>/GJ

$QF_c$  = Quantity of fuel consumed for each mobile and stationary emission source 'c'<sup>49</sup> GJ/yr

0.001 = Conversion factor from kg to metric tons

\* If total electricity being generated by project activities is  $\geq$  the additional electricity consumption, then  $QE_c$  shall not be accounted for in the project emissions and shall be omitted from the equation above.

<sup>48</sup> The average total output emissions rate for the reporting period should be used from the Argentina Wholesale Electricity Market Clearing Company (Spanish abv. CAMMESA), available at: <https://cammesaweb.cammesa.com/estadistica-informe-sintesis-mem/>.

<sup>49</sup> If the quantity of fuel consumed is given in mass (kg or tones) or volume (L or m<sup>3</sup>) units, convert it into energy units by multiplying the fuel quantity by its net calorific value. Use the calorific value provided by the fuel supplier or a laboratory analysis, if it is not available use the net calorific values provided in Appendix B, Table B.6.

## 6 Project Monitoring

The Reserve requires a Monitoring Plan to be established for all monitoring and reporting activities associated with the project. The Monitoring Plan will serve as the basis for verification bodies to confirm that the monitoring and reporting requirements in this section and Section 7 have been and will continue to be met, and that consistent, rigorous monitoring and record-keeping is ongoing at the project site. The Monitoring Plan must cover all aspects of monitoring and reporting contained in this protocol and must specify how data for all relevant parameters in Table 6.1 will be collected and recorded.

At a minimum the Monitoring Plan shall stipulate the frequency of data acquisition; a record keeping plan (see Section 7.2 for minimum record keeping requirements); the frequency of instrument field check and calibration activities; and the role of individuals performing each specific monitoring activity. The Monitoring Plan should include QA/QC provisions to ensure that data acquisition and meter calibration are carried out consistently and with precision.

Finally, the Monitoring Plan must include procedures that the project developer will follow to ascertain and demonstrate that the project at all times passes the Legal Requirement Test (Section 3.5.3).

Project developers are responsible for monitoring the performance of the project and operating each component of the biogas collection and destruction system in a manner consistent with the manufacturer's recommendations.

### 6.1 Site-Specific Determination of Maximum Methane Potential ( $B_0$ )<sup>50</sup>

The determination of a site-specific value for maximum methane potential ( $B_0$ ) is optional for manure from dairy facilities. Swine and beef cattle facilities must use the default values. For projects that choose this option for the quantification of emission reductions related to one or more manure streams being digested in the project's BCS, or the BCS effluent, the following criteria must be met in order to ensure accuracy and consistency of the site-specific  $B_0$  values:

1. Manure samples for each eligible livestock category must be sampled prior to mixing with manure from other animal categories or any other waste streams. These samples shall be taken from the manure collection system, rather than from an individual animal.
  - a. Scrape systems: Samples shall be collected from the freshly scraped manure.
  - b. Flush systems: Samples shall be collected at the point that the flushed manure leaves the barn. Additional samples must be collected of the flush water prior to mixing with manure.
  - c. BCS effluent: Samples shall be collected after the effluent has exited the digester and prior to any further treatment.
2. Sampling events shall occur during the time period between February and June, inclusive.
  - a. Manure samples: For each eligible animal category, there shall be one single-day sampling event. A total of at least six samples of at least one-half liter each must be taken during the event. Samples shall be taken one to three hours apart, and

---

<sup>50</sup> Background information on the development of this section can be found in Appendix E.

- all samples of the same type shall be combined (i.e., dairy cow manure samples in one container). The composite sample shall be delivered to the testing laboratory within 24 hours following the collection of the final sample.<sup>51</sup>
- b. Flush water samples: If the farm utilizes a flush system for manure collection, the flush water must be sampled prior to mixing with manure. Two samples of at least one liter shall be collected, one to three hours apart, during the manure sampling event. These samples shall be combined into one container and delivered to the testing laboratory within 24 hours of the sampling event.
  - c. Effluent samples: Two samples of at least one liter shall be collected, one to three hours apart, during the manure sampling event. These samples shall be combined into one container and delivered to the testing laboratory within 24 hours of the sampling event.
3. All samples must be analyzed using a Biochemical Methane Potential (BMP) Assay procedure at an independent, third-party laboratory that is familiar and experienced with this test and ISO 11734.<sup>52</sup> The laboratory must be able to document at least three years of experience with the BMP assay and must have procedures in place to maintain a consistent inoculum.<sup>53</sup> The laboratory must maintain and follow a standard operating procedure that outlines the process used in undertaking BMP analysis at that laboratory, and which can be made available to the verifier upon request.
  4. At least six test runs shall be conducted using material from the mixed manure sample (i.e., split the sample into two and test each in triplicate). Tests shall report the weight of VS for the sample (as kg of dry matter) as well as the volume of methane produced, in order to determine the maximum methane potential as  $\text{m}^3 \text{CH}_4/\text{kg VS}$ . If applicable, the flush water sample and effluent sample shall each be used for one test run in triplicate. The laboratory shall conduct an assay on the seed inoculum itself in order to control for its contribution to the methane potential of the manure samples. The laboratory shall also conduct a control assay with a substrate of known methane potential (such as glucose or cellulose) to verify correct procedures were followed and that the inoculum was viable. If the control assay differs from its established expected value by greater than 15%, all results from that batch of assays shall be discarded. Measurement of gas flow shall be corrected to standard temperature and pressure (0°C and 1 atm). Devices used to measure gas flow and methane content shall be properly installed and calibrated, such that they can provide results within +/- 5% accuracy.
  5. After the manure sample has been analyzed, there should be at least six estimates for the methane potential. The site-specific value for  $B_0$  shall equal the 90% lower confidence limit of all assay results. For flush systems, the mean methane potential of the flush water results must be subtracted from the calculated methane potential of the flushed manure sample. For BCS effluent, the mean methane potential of the test results

---

<sup>51</sup> It is recommended that the samples are sent for testing within 24 hours of the sampling event. The longer a sample is retained before testing, the lower the methane potential will be. This loss can be mitigated by storing and transporting samples at temperatures below 5°C.

<sup>52</sup> For more information on BMP Assay analysis and procedures, see Moody et al. "Use Biochemical Methane Potential (BMP) Assays for Predicting and Enhancing Anaerobic Digester Performance." (2009). <https://dr.lib.iastate.edu/server/api/core/bitstreams/fe3b803-c0b4-4a34-ae53-8f7693f3a666/content>

<sup>53</sup> Inoculum is defined as the population of microorganisms or cells that is introduced in the fermentation medium or any other suitable medium.



shall be used for the quantification. Additional sampling and assays may be carried out and will reduce uncertainty and result in a final value that is closer to the mean.

For projects located in Cordoba, the General Directorate of Technical Development of the Ministry of the Environment provides a list of laboratories<sup>54</sup> that carry out environmental sampling, analysis, and/or measurements within the jurisdiction. However, project developers must confirm that the laboratory selected meets the requirements outlined in this Section.

Project developers may utilize laboratories outside of Argentina where the project is located if they meet the requirements outlined in this section. When transporting the sample to the laboratory outside of the jurisdiction, the integrity of the sample must be maintained throughout the chain of custody. The Reserve will continue to assess the eligibility of the laboratories in Argentina for compliance with these requirements as required.

Site-specific  $B_0$  values determined using this procedure shall be valid for the reporting period during which the sampling occurred. Projects may elect to determine a site-specific  $B_0$  value for only a subset of the eligible manure streams and utilize default values for the remainder. The verifier must confirm that sampling procedures conform to this section and that the personnel responsible for the sampling are trained and competent.

## 6.2 Monitoring Requirements

The methane capture and control system must be monitored with measurement equipment that directly meters:

- The total flow of biogas, measured continuously and recorded every 15 minutes or totalized and recorded at least daily, adjusted for temperature and pressure, prior to delivery to the destruction device(s);
- The flow of biogas delivered to each destruction device,<sup>55</sup> measured continuously and recorded every 15 minutes or totalized and recorded at least daily, adjusted for temperature and pressure;
- The fraction of methane in the biogas, measured with a continuous analyzer or, alternatively, with quarterly measurements; and
- Operational status of each destruction device (except as described below), measured and recorded at least hourly.

Flow data must be corrected for temperature and pressure at 0°C and 1 atm, either internally or by following the guidance in Equation 5.6.

A single flow meter may be used to monitor the flow of gas to multiple destruction devices under certain conditions. If all destruction devices are of identical methane destruction efficiency (as described in If available, the official source tested methane destruction efficiency shall be used in place of the default methane destruction efficiency. Otherwise, project developers have the

---

<sup>54</sup> List available on the Official Registry of Environmental Laboratories: <https://cidi.cba.gov.ar/portal-publico/tramite/317CF416-78F0-EB11-BCE9-005056A190FF>

<sup>55</sup> A single meter may be used for multiple, identical destruction devices. In this instance, methane destruction in these units will be eligible only if both units are monitored to be operational.

option to use either the default methane destruction efficiencies provided, or the site-specific methane destruction efficiencies as provided by a provincial or local agency accredited source test service provider, for each of the combustion devices used in the project case performed on an annual basis (Table B.7) and verified to be operational (i.e., there is recorded evidence of destruction), no additional steps are necessary for project registration. One example of this scenario would be a single meter used for a bank of multiple, identical engines that are in constant operation. If the destruction devices are not of identical efficiency, then the destruction efficiency of the least efficient device shall be applied to the flow data for this meter.

If there are any periods where the operational data show that one or more devices were not destroying methane, these periods are still eligible for crediting, provided that the verifier can confirm all of the following conditions are met:

- a. The destruction efficiency of the least efficient destruction device in operation shall be used as the destruction efficiency for all destruction devices monitored by this meter;
- b. All devices are either equipped with valves on the input gas line that close automatically if the device becomes non-operational (requiring no manual intervention), or designed in such a manner that it is physically impossible for gas to pass through while the device is non-operational; and
- c. For any period where one or more destruction device(s) within this arrangement is not operational, it must be documented that the remaining operational devices have the capacity to destroy the maximum gas flow recorded during the period. For devices other than flares, it must be shown that the output corresponds to the flow of gas.

Figure 6.1 represents the suggested arrangement of the biogas flow meters and methane concentration metering equipment.

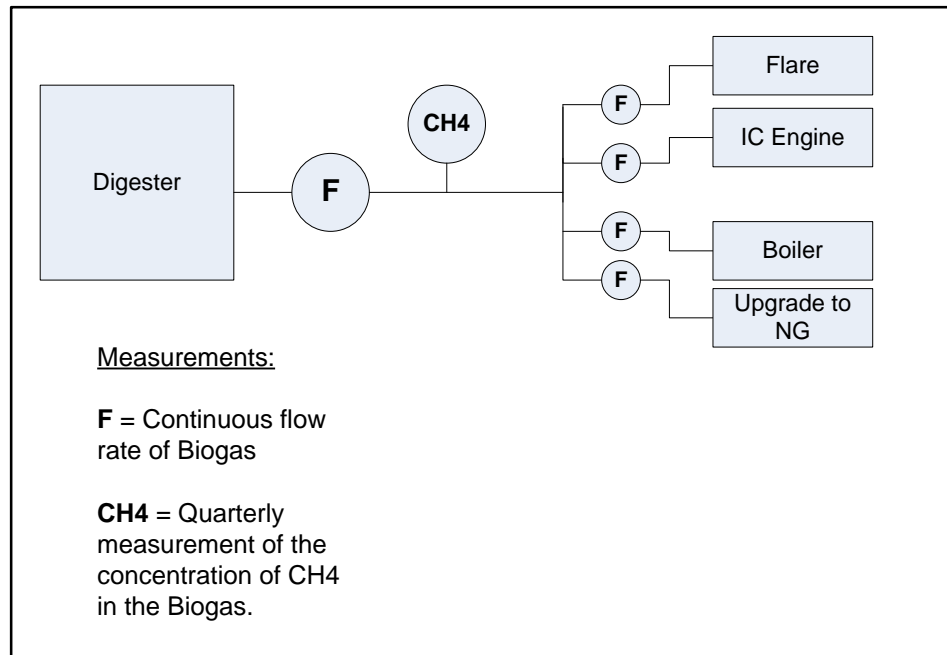

Note: The number of flow meters must be sufficient to track the total flow as well as the flow to each combustion device. The above scenario includes one more flow meter than would be necessary to achieve this objective.

**Figure 6.1.** Suggested Arrangement of Biogas Metering Equipment

Operational activity of the biogas collection system and the destruction devices shall be monitored and documented at least hourly to ensure actual methane destruction. GHG reductions will not be accounted for or credited during periods which the destruction device is not operational. This period is defined as the time between the flow reading preceding and following the outage. Alternatively, any destruction device equipped with a safety shut off device that prevents biogas flow to the destruction device when the destruction device is not operational does not require hourly monitoring, provided that the presence, operability, and use of the safety device are verified.

If for any reason the destruction device or the operational monitoring equipment (for example, the thermal coupler on the flare) is inoperable, then all metered biogas going to the particular device shall be assumed to be released to atmosphere during the period of inoperability. During the period of inoperability, the destruction efficiency of the device must be assumed to be zero. In Equation 5.6 the monthly destruction efficiency (BDE) value shall be adjusted accordingly. As an example, consider the primary destruction device to be an open flare with a BDE of 96% and it is found to be inoperable for a period of 5 days of a 30-day month. In this case the monthly BDE would be  $(0.96 \times 25)/30 = 80\%$ .

### 6.3 Biogas Measurement Instrument QA/QC

All gas flow meters<sup>56</sup> and continuous methane analyzers must be:

- Cleaned and inspected on a quarterly basis, with the activities performed and as found/as left condition of the equipment documented.
- Field checked by an appropriately trained individual for calibration accuracy with the percent drift documented, using either a portable instrument (such as a pitot tube)<sup>57</sup> or manufacturer specified guidance, at the end of but no more than two months prior to the end date of the reporting period.<sup>58</sup>
- Calibrated by the manufacturer or a certified calibration service per manufacturer's guidance or every 5 years when calibration frequency is not specified by the manufacturer.

Conformance with the factory calibration requirement is only required during periods of time where data gathered by the meter are used for emission reduction quantification. Periods where the meter did not meet this requirement will not cause the project to fail the requirement, provided the meter was not being used for project emission reduction quantification during such periods, and provided the meter was brought back into conformance before being employed to gather project data. Periods while the meter is not in use must still be considered when determining when to calibrate the device. For example, a continuous flow meter was calibrated on January 1, 2015 and the manufacturer requires the device to be calibrated every 5 years. The meter was in use beginning February 1, 2015 and was removed on December 31, 2016, and then re-installed February 1, 2020. The flow meter must be calibrated by January 1, 2020 in order to be in conformance with the manufacturer specifications.

If a stationary meter that was in use for 60 days or more – which may span two reporting periods – is removed and not reinstalled during a reporting period, that meter shall either be

- field-checked for calibration accuracy within 2 months of removal; or
- calibrated (with percent drift documented) by the manufacturer or a certified calibration service (with as-found results recorded) no more than 12 months prior to use of the meter to quantify emission reductions and no later than the commencement of verification activities for the relevant reporting period.

---

<sup>56</sup> Field checks and calibrations of flow meters shall assess the volumetric output of the flow meter.

<sup>57</sup> It is recommended that a professional third-party calibration service be hired to perform flow meter field checks if using pitot tubes or other portable instruments, as these types of devices require professional training in order to achieve accurate readings.

<sup>58</sup> Instead of performing field checks, the project developer may instead have equipment calibrated by the manufacturer or a certified calibration service per manufacturer's guidance, at the end of but no more than two months prior to the end date of the reporting period to meet this requirement.

The as-found condition (percent drift<sup>59</sup>) of a field check must be recorded. If a piece of equipment reveals accuracy outside of a +/- 5% threshold, calibration by the manufacturer or a certified service provider is required for that equipment.

For the interval between the last successful field check and any calibration event that confirms accuracy below the +/- 5% threshold, all data from that meter or analyzer must be scaled according to the following procedure. These adjustments must be made for the entire period from the last successful field check to the time the meter was correctly calibrated, unless the last event occurred during the prior reporting period, in which case adjustment is made back to the beginning of the current reporting period. If at the time of the failed field check, the meter is cleaned and checked again, with the as-left condition found to be within the accuracy threshold, full calibration is not required for that piece of equipment. This shall be considered a failed field check followed by a successful field check. The data adjustment shall be based on the percent drift recorded at the time of the failed field check. However, if the as-left condition remains outside of the +/- 5% threshold (whether or not additional cleaning and accuracy testing occurs), calibration by the manufacturer or a certified service provider is required for that piece of equipment.

For calibrations that include meter confirmation of accuracy outside of a +/- 5% threshold, the project developer must estimate total emission reductions using i) uncorrected measured values, and ii) measured values adjusted for the largest recorded movement of the calibration at this time. The more conservative value of the two emissions estimates is reported as the reduced emissions estimate.

For example, if a project conducts field checks quarterly during a year-long reporting period, then only three months of data will be subject at any one time to the penalties above. However, if the project developer feels confident that the meter does not require field checks or calibration on a greater than annual basis, then failed events will accordingly require the penalty to be applied to the entire year's data. Further, frequent calibration may minimize the total accrued drift (by zeroing out any error identified), and result in smaller overall deductions.

In order to provide flexibility in verification, data monitored up to two months after a field check may be verified. As such, the end date of the reporting period must be no more than two months after the latest successful field check.

If a portable instrument is used, such as a handheld methane analyzer, the portable instrument shall be calibrated at least annually by the manufacturer or at an ISO 17025 accredited laboratory.

### 6.3.1 Missing Data

In situations where the flow rate or methane concentration monitoring equipment is missing data, the project developer shall apply the data substitution methodology provided in Appendix D. This methodology may also be used for periods where the project developer can show that the data are available but known to be corrupted (and where this corruption can be verified with reasonable assurance). If for any reason the monitoring equipment on any given destruction

---

<sup>59</sup> Percent drift should be calculated based on the expected value for the livestock operation, thus, percent drift = ((actual value-expected value) / expected value) x 100%

device is inoperable (for example, the thermocouple on the flare) or the presence and operability of the safety shut off valve cannot be verified, then the destruction efficiency of that device must be assumed to be zero. For instances when it is not possible to use data substitution to fill data gaps, no emission reductions may be claimed for that period. The methane flow volume for those days shall be zero, and the number of reporting days for that month shall be reduced to exclude the days of missing data.

During any period where the project is not claiming emission reduction credits and is not classifying the period as a venting event, the project developer must be able to demonstrate that project emissions were not greater than baseline emissions.

## **6.4 Monitoring Parameters**

Provisions for monitoring other variables to calculate baseline and project emissions are provided in Table 6.1. The parameters are organized by general project factors and then by the calculation methods.

**Table 6.1.** Project Monitoring Parameters

Parameter	Description	Data unit	Calculated (c) Measured (m) Reference (r) Operating Records (o)	Measurement frequency	Comments
<b>General Project Parameters</b>					
Regulations	Project developer attestation to compliance with regulatory requirements relating to the manure digester project	All applicable regulations	n/a	Annually	Information used for:  1) Demonstrate the ability to comply with the Regulatory Test – when the regulation requires the installation of a biogas system.  2) Demonstrate compliance with associated environmental regulations, for example, effluent discharge limits and criteria pollutants.  Verifier: Determine the regulatory agencies in charge of regulating the livestock operation; review regulations and permits corresponding to livestock operation.
L	Type of livestock categories on the farm	Livestock categories	o	Monthly	Select from list provided in Appendix B, Table B.2.  <i>Verifier:</i> Review herd management software;  Conduct site visit;  Interview operator.

Parameter	Description	Data unit	Calculated (c) Measured (m) Reference (r) Operating Records (o)	Measurement frequency	Comments
MS <sub>L</sub>	Fraction of manure from each livestock category managed in the baseline waste handling system 'S'	Percent (%)	o	Every reporting period	Reflects the percent of waste handled by the system components 'S' pre-project. Applicable to the entire operation. Within each livestock category, the sum of MS values (for all treatment/storage systems) equals 100%. Select from list provided in Appendix B, Table B.1.  <i>Verifier:</i> Conduct site visit; Interview operator; Review baseline scenario documentation.
P <sub>L</sub>	Average number of animals for each livestock category	Population (# head)	o	Monthly	<i>Verifier:</i> Review the livestock management software or record; Review submissions of water or air quality reports, if reported to local, provincial, or federal authorities.
Mass <sub>L</sub>	Average animal mass by livestock category	kg	o, r	Monthly	From operating records, or if onsite data is unavailable, from lookup table (Appendix B, Table B.2).  <i>Verifier:</i> Conduct site visit; Interview livestock operator; Review average daily gain records, operating records.
T	Average monthly temperature at location of the operation	°C	m/o	Monthly	Used for van't Hoff Calculation and for choosing appropriate MCF value.  <i>Verifier:</i> Review temperature records obtained from weather service.
<b>Baseline Methane Calculation Variables</b>					



Parameter	Description	Data unit	Calculated (c) Measured (m) Reference (r) Operating Records (o)	Measurement frequency	Comments
B <sub>0,L</sub>	Maximum methane producing capacity for manure by livestock category	(m <sup>3</sup> CH <sub>4</sub> /kg VS)	r	Annually	From Appendix B, Table B.3. <i>Verifier:</i> Verify correct value from table used.
MCF <sub>s</sub>	Methane conversion factor for manure management system component 'S'	Percent (%)	r	Annually	From Appendix B, Table B.4. Differentiate by livestock category <i>Verifier:</i> Verify correct value from table used.
VS <sub>L</sub>	Daily volatile solid production	(kg/animal/day)	r, c	Every reporting period	Appendix B, Table B.3; see Box 5.1 for guidance on adjusting default values. <i>Verifier:</i> Ensure appropriate year's table is used; Review data units.
VS <sub>avail</sub>	Monthly volatile solids available for degradation in each anaerobic storage system, for each livestock category	kg	c, o	Monthly	Calculated value from operating records. Recommend Reserve's Livestock Calculation Tool for all calculations. <i>Verifier:</i> Ensure proper use of Reserve's Livestock Calculation Tool; Review operating records.

Parameter	Description	Data unit	Calculated (c) Measured (m) Reference (r) Operating Records (o)	Measurement frequency	Comments
VS <sub>deg</sub>	Monthly volatile solids degraded in each anaerobic storage system, for each livestock category	kg	c, o	Monthly	Calculated value from operating records. Recommend Reserve's Livestock Calculation Tool for all calculations.  <i>Verifier:</i> Ensure proper use of Reserve's Livestock Calculation Tool; Review operating records.
<i>f</i>	van't Hoff-Arrhenius factor	n/a	c	Monthly	The proportion of volatile solids that are biologically available for conversion to methane based on the monthly temperature of the system. Recommend Reserve's Livestock Calculation Tool for all calculations.  <i>Verifier:</i> Ensure proper use of Reserve's Livestock Calculation Tool; Review calculation; Review temperature data.
<b>Project Methane Calculation Variables – BCS + Effluent Pond</b>					
CH <sub>4, destroyed</sub>	Aggregated amount of methane collected and destroyed in the biogas control system	Metric tons of CH <sub>4</sub>	c, m	Every reporting period	Calculated as the collected methane times the destruction efficiency (see the 'CH <sub>4, meter</sub> ' and 'BDE' parameters below).  <i>Verifier:</i> Review meter reading data; Confirm proper operation of the destruction device(s); Ensure data is accurately aggregated over the correct amount of time.

Parameter	Description	Data unit	Calculated (c) Measured (m) Reference (r) Operating Records (o)	Measurement frequency	Comments
CH <sub>4,meter</sub>	Amount of methane collected and metered in biogas control system	Metric tons of CH <sub>4</sub> (tCH <sub>4</sub> )	c, m	Monthly	Calculated from biogas flow and methane fraction meter readings (see 'F' and 'CH <sub>4,conc</sub> ' parameters below).  <i>Verifier:</i> Review meter reading data; Confirm proper operation, in accordance with the manufacturer's specifications; Confirm meter calibration data.
F	Monthly volume of biogas from digester to destruction devices	m <sup>3</sup> /month	m	Continuously, aggregated monthly	Measured and recorded continuously from flow meter (every 15 minutes) or in an accumulated manner at least daily. Data to be aggregated monthly.  <i>Verifier:</i> Review meter reading data; Confirm proper aggregation of data; Confirm proper operation in accordance with the manufacturer's specifications; Confirm meter calibration data.
T	Temperature of the biogas	°C	m	Continuously, averaged  Monthly	Measured to normalize volume flow of biogas to STP (0°C, 1 atm). No separate monitoring of temperature is necessary when using flow meters that automatically measure temperature and pressure, expressing biogas volumes in normalized cubic meters.
P	Pressure of the biogas	atm	m	Continuously, averaged  Monthly	Measured to normalize volume flow of biogas to STP (1 atm, 0°C). No separate monitoring of pressure is necessary when using flow meters that automatically measure temperature and pressure, expressing biogas volumes in normalized cubic meters.

Parameter	Description	Data unit	Calculated (c) Measured (m) Reference (r) Operating Records (o)	Measurement frequency	Comments
CH <sub>4,conc</sub>	Methane concentration of biogas	Percent (%)	m	Quarterly	Use a direct sampling approach that yields a value with at least 95% confidence. Samples to be taken at least quarterly.  Calibrate monitoring instrument in accordance with the manufacturer's specifications.  <i>Verifier:</i> Review meter reading data; Confirm proper operation, in accordance with the manufacturer's specifications.
BDE	Methane destruction efficiency of destruction device(s)	Percent (%)	r, c	Monthly	Reflects the actual efficiency of the system to destroy captured methane gas, accounts for different destruction devices (see guidance and default factors in Equation 5.6).  <i>Verifier:</i> Confirm proper and continuous operation in accordance with the manufacturer's specifications.
BCE	Biogas capture efficiency of the anaerobic digester, accounts for gas leaks	Percent (%)	r	Every reporting period	Default value is 85%. Project developers may justify a higher BCE using verifiable evidence.  <i>Verifier:</i> Review operation and maintenance records to ensure proper functionality of BCS; Assess claims that BCE is higher than default.
VS <sub>ep</sub>	Average daily volatile solid of digester effluent to effluent pond	kg/day	c	Annually	If project uses effluent pond, equals 30% of the average daily VS entering the digester (from ACM0010 -V2 Annex I).

Parameter	Description	Data unit	Calculated (c) Measured (m) Reference (r) Operating Records (o)	Measurement frequency	Comments
					<i>Verifier:</i> Review $VS_{ep}$ calculations.
$MS_{L,BCS}$	Fraction of manure from each livestock category managed in the biogas control system	Percent (%)	o	Annually	Used to determine the total VS entering the digester. The percentage should be tracked in operational records.  <i>Verifier:</i> Check operational records and conduct site visit.
$B_{0,ep}$	Maximum methane producing capacity for manure to effluent pond	( $m^3 CH_4/kgVS$ )	c	Annually	An average of the $B_{0,ep}$ value of the operation's livestock categories that contribute manure to the biogas control system.  <i>Verifier:</i> Check calculation.
$MCF_{ep}$	Methane conversion factor for biogas control system effluent pond	Percent (%)	r	Annually	Appendix B, Table B.4, (from IPCC v.4, chapter 10, Table 10.17). Project developers should use the <i>liquid slurry</i> MCF value.  <i>Verifier:</i> Verify value from table.
$MS_{BCS}$	The maximum biogas storage of the BCS system	$m^3$	r	Every reporting period	Obtained from digester system design plans. Necessary to quantify the release of methane to the atmosphere due to an uncontrolled venting event.
$F_{pw}$	The average flow of biogas from the digester for the entire week prior to	$m^3/day$	m	Weekly	The average flow of biogas can be determined from the daily records from the previous week.

Parameter	Description	Data unit	Calculated (c) Measured (m) Reference (r) Operating Records (o)	Measurement frequency	Comments
	the uncontrolled venting event				
t	The number of days of the month that biogas is venting uncontrolled from the project's BCS	Days	m, o	Monthly	The number of days of the month that biogas is venting uncontrolled from the project's BCS.
<b>Project Methane Calculation Variables – Non-BCS Related Sources</b>					
MS <sub>L,S</sub>	Fraction of manure from each livestock category managed in non-anaerobic manure management system component 'S'	Percent (%)	o	Monthly	Based on configuration of manure management system, differentiated by livestock category. <i>Verifier:</i> Conduct site visit; Interview operator.
EF <sub>CH<sub>4</sub>,L</sub> (nBCSs)	Methane emission factor for the livestock population from non-BCS related sources	(kg CH <sub>4</sub> /head/year)	c	Annually	Emission factor for all non-BCS storage systems, differentiated by livestock category (see Equation 5.8). <i>Verifier:</i> Review calculation, operations records.
<b>Baseline and Project CO<sub>2</sub> Calculation Variables</b>					

Parameter	Description	Data unit	Calculated (c) Measured (m) Reference (r) Operating Records (o)	Measurement frequency	Comments
EF <sub>CO<sub>2</sub>,f</sub>	Fuel-specific emission factor for mobile and stationary combustion sources	kg CO <sub>2</sub> /TJ	r	Annually	Refer to Appendix B, Table B.5 for emission factors. If biogas produced from digester is used as an energy source, the EF is zero.  <i>Verifier:</i> Review emission factors.
QF <sub>c</sub>	Quantity of fuel used for mobile/stationary combustion sources	TJ/year or lt/year or m <sup>3</sup> /year	o, c	Annually	Fuel used by project for manure collection, transport, treatment/storage, and disposal, and stationary combustion sources including supplemental fossil fuels used in combustion device.  <i>Verifier:</i> Review operating records and quantity calculation; Review calorific values.
EF <sub>CO<sub>2</sub>,e</sub>	Emission factor for electricity used by project	tCO <sub>2</sub> /MWh	r	Every reporting period	If biogas produced from digester is used to generate electricity consumed, the emission factor is zero.  <i>Verifier:</i> Review emission factors.
QE <sub>c</sub>	Quantity of electricity consumed	MWh/year	o, c	Every reporting period	Electricity used by project for manure collection, transport, treatment/storage, and disposal.  <i>Verifier:</i> Review operating records and quantity calculation.

## 7 Reporting Parameters

This section provides requirements and guidance on reporting rules and procedures. A priority of the Reserve is to facilitate consistent and transparent information disclosure among project developers. Project developers must submit either a project Monitoring Report or a verified emission reduction report to the Reserve annually at a minimum, depending on the verification option selected by the project developer.

### 7.1 Project Documentation

Project developers must provide the following documentation to the Reserve in order to list a livestock project:

- Project Submittal form
- Pre-project diagram (not public)
- Project diagram (not public)

Project developers must provide the following documentation each verification period in order for the Reserve to issue CRTs for quantified GHG reductions:

- Completed Calculation Tool (not public)
- Project diagram – only if there has been a change since the previous reporting period
- Project Monitoring Report (not public)
- Social and Environmental Safeguards Evaluation Form
- Project Data Report
- Verification Report
- Verification Opinion
- Signed Attestation of Title form
- Signed Attestation of Voluntary Implementation form
- Signed Attestation of Regulatory Compliance form
- Signed Attestation of No Conflicts form

The above project documentation will be available to the public via the Reserve's online registry. Further disclosure and other documentation may be made available on a voluntary basis through the Reserve. Project forms can be found at <https://www.climateactionreserve.org/how/program-resources/documents/>

#### 7.1.1 Project Data Report

A Project Data Report (PDR) is a required document for reporting information about a project. The document must be submitted for every reporting period. A PDR template has been prepared by the Reserve and is available on the Reserve's website. The template is organized to assist in ensuring that all requirements of the protocol are addressed. PDRs are intended to serve as the main project document that thoroughly describes how the project meets eligibility requirements, discusses the quantification methodologies utilized to generate project estimates, and outlines how the project complies with terms for additionality. PDRs must be of professional quality and free of incorrect citations, missing pages, incorrect project references, etc.



## 7.2 Record Keeping

For purposes of independent verification and historical documentation, project developers shall be required to keep all information outlined in this protocol for a period of 10 years after the information is generated. This information will not be publicly available but may be requested by the verifier or the Reserve.

### Social and Environmental Safeguards:

- Documentation of the Free, Informed, and Prior Consent that was presented to the livestock operator and/or relevant participants at the project livestock operation site.
- Historical records and ongoing monitoring and reporting of safeguards through data logging of physical measurements, online sources, and government data.
- Executed Attestation of No Conflicts
- All other methods and procedures in place for the project to adhere to social and environmental safeguards requirements.

### System Information:

- All data inputs for the calculation of the baseline emissions and project emission reductions
- CO<sub>2</sub>e annual tonnage calculations
- Relevant sections of the biogas control system operating permits
- Executed Attestation of Title forms, Attestation of Regulatory Compliance forms, and Attestation of Voluntary Implementation forms
- Biogas control system information (installation dates, equipment list, etc.)
- Biogas flow meter information (model number, serial number, manufacturer's calibration procedures)
- Methane monitor information (model number, serial number, calibration procedures)
- Cleaning and inspection records for all biogas meters
- Field check results for all biogas meters
- Biogas flow data (for each flow meter)
- Biogas flow meter calibration data (for each flow meter)
- Biogas temperature and pressure readings (only if flow meter does not correct for temperature and pressure automatically)
- Methane concentration monitoring data
- Methane concentration monitor calibration data
- Destruction device monitoring data (for each destruction device)
- Destruction device, methane monitor and biogas flow monitor information (model numbers, serial numbers, calibration procedures)
- Initial and annual verification records and results

- All maintenance records relevant to the biogas control system, monitoring equipment, and destruction devices

**If using a calibrated portable gas analyzer for CH<sub>4</sub> content measurement:**

- Date, time, and location of methane measurement
- Methane content of biogas (% by volume) for each measurement
- Methane measurement instrument type and serial number
- Date, time, and results of instrument calibration
- Corrective measures taken if instrument does not meet performance specifications

## **7.3 Reporting Period and Verification Cycle**

### **7.3.1 Reporting Periods**

The reporting period is the length of time over which GHG emission reductions from project activities are quantified. Project developers must report GHG reductions resulting from project activities during each reporting period. A reporting period may not exceed 12 months in length, except for the initial reporting period, which may cover up to 24 months. The Reserve accepts verified emission reduction reports on a sub-annual basis, should the project developer choose to have a sub-annual reporting period and verification schedule (e.g., monthly, quarterly, or semiannually). Reporting periods must be continuous; there must be no gaps in reporting during the crediting period of a project once the first reporting period has commenced.

### **7.3.2 Verification Periods**

The verification period is the length of time over which GHG emission reductions from project activities are verified. The initial verification period for a livestock project is limited to one reporting period of up to 24 months of data. Subsequent verification periods may cover up to two reporting periods, with a maximum of 24 months of data (i.e., 12 months of data per reporting period). CRTs will not be issued for reporting periods that have not been verified. For any reporting period that ends prior to the end of the verification period (i.e., year 1 of a 2-year verification period), an interim monitoring report must be submitted to the Reserve no later than six months following the end of the relevant reporting period. The interim monitoring report shall contain a summary of emission reductions, description of QA/QC activities, and description of potential nonconformances, data errors, metering issues, or material changes to the project.<sup>60</sup> All mandatory sections of interim monitoring reports must be verified in the subsequent verification.

To meet the verification deadline, the project developer must have the required verification documentation (see Section Project Documentation 7.1) submitted within 12 months of the end of the verification period. The end date of any verification period must correspond to the end of a reporting period.

### **7.3.3 Verification Site Visit Schedule**

---

<sup>60</sup> A template monitoring report is available on the Argentina Livestock Protocol webpage.

A site visit must occur during the initial verification, and at least once every two reporting periods thereafter. A reporting period may be verified without a new site visit if the following requirements are met:

1. A new site visit occurred in conjunction with the previous reporting period;
2. The current verification is being conducted by the same verification body that conducted the site visit for the previous verification; and
3. There have been no significant changes in data management systems, equipment, or personnel since the previous site visit.

The above requirements apply regardless of whether the verification period contains one or two reporting periods. The Reserve maintains the discretion to require a new site visit for a reporting period despite satisfaction of the above requirements. For example, the approval of a significant variance during the reporting period could be considered grounds for denial of the option to forego a site visit for the verification.

## 8 Verification Guidance

This section provides verification bodies with guidance on verifying GHG emission reductions associated with installing a biogas control system for manure management on dairy cattle and swine farms. This verification guidance supplements the Reserve's Verification Program Manual and describes verification activities specifically related to livestock manure management projects.

Verification bodies trained to verify livestock projects must be familiar with the following documents:

- Reserve Program Manual
- Reserve Verification Program Manual
- Reserve Argentina Livestock Protocol

The Reserve's Program Manual, Verification Program Manual, and project protocols are designed to be compatible with each other and are available on the Reserve's website at <http://www.climateactionreserve.org>.

In cases where the Program Manual and/or Verification Program Manual differ from the guidance in this protocol, this protocol takes precedent.

ISO-accredited verification bodies trained by the Reserve for this project type are eligible to verify livestock projects. Verification bodies approved under other Reserve or California Air Resources Board waste handling and methane destruction protocol types are also permitted to verify livestock projects in Argentina. Verification bodies and project developers should consider if the verification team has the necessary language capabilities to perform and complete verification activities. Information about verification body accreditation and Reserve project verification training can be found on the Reserve website at <http://www.climateactionreserve.org>.

### 8.1 Standard of Verification

The Reserve's standard of verification for livestock projects is Argentina Livestock Protocol (this document), the Reserve Program Manual, and the Verification Program Manual. To verify a livestock project report, verification bodies apply the guidance in the Verification Program Manual and this section of the protocol to the standards described in Sections 2 through 7 of this protocol. Sections 2 through 7 provide eligibility rules, methods to calculate emission reductions, performance monitoring instructions and requirements, and procedures for reporting project information to the Reserve.

### 8.2 Monitoring Plan

The Monitoring Plan serves as the basis for verification bodies to confirm that the monitoring and reporting requirements in Section 6 and Section 7 have been met, and that consistent, rigorous monitoring and record-keeping is ongoing at the project site. Verification bodies shall confirm that the Monitoring Plan covers all aspects of monitoring and reporting contained in this protocol and specifies how data for all relevant parameters in Section 6 are collected and recorded.

### 8.3 Verifying Project Eligibility

Verification bodies must affirm a livestock project's eligibility according to the rules described in this protocol. The table below outlines the eligibility criteria for livestock projects. This table does not present all criteria for determining eligibility comprehensively; verification bodies must also look to Section 3 and the verification items list in Table 8.1.

**Table 8.1.** Summary of Eligibility Criteria for a Livestock Project

Eligibility Rule	Eligibility Criteria	Frequency of Rule Application
Start Date	Projects must be submitted for listing within 12 months of the project start date	During the first verification of the initial reporting period for each crediting period (including renewed crediting periods)
Location	Argentina	During the first verification of the initial reporting period for each crediting period (including renewed crediting periods)
Performance Standard	Installation of a biogas control system that captures and destroys methane gas from anaerobic manure treatment and/or storage facilities on livestock operations	During the first verification of the initial reporting period for each crediting period (including renewed crediting periods)
Anaerobic Baseline	Projects must demonstrate that the depth of the anaerobic lagoons or ponds prior to the project's implementation were sufficient to prevent algal oxygen production and create an oxygen-free bottom layer; which means at least 1 meter in depth	During the first verification of the initial reporting period for each crediting period (including renewed crediting periods)
Legal Requirement Test	Signed Attestation of Voluntary Implementation form and additional documentation demonstrating that the project passes the Legal Requirement Test	Every verification
Regulatory Compliance Test	Signed Attestation of Regulatory Compliance form and disclosure of all non-compliance events to verifier, and monitoring; project must be in material compliance with all applicable laws	Every verification
Social Safeguard 1 - FPIC	Signed documentation demonstrating compliance with social safeguard 1 FPIC.	Once during first verification
Social Safeguard 2- Ongoing Notification, Participation, and Documentation	Signed documentation demonstrating compliance with social safeguard 2 Ongoing Notification, Participation, and Documentation.	Every verification
Social Safeguard 3 – Labor and Safety	Signed Attestation of Regulatory Compliance form attesting to be in material compliance with all applicable laws, including labor and safety. Verifiers should contact the National Registry of	Every verification

	Rural Workers and Employers (RENATRE) and/or other applicable government agencies.	
Social Safeguard 4 – Respect Local Land Tenure Rights & No Conflicts	Signed Attestation of No Conflict attesting that there are no land tenure disputes that affect the project boundary, including all livestock facilities directly associated with the carbon project.	Every verification
Environmental Safeguard 1 – Air and Water Quality	Signed Attestation of Regulatory Compliance form attesting to be in material compliance with all applicable laws, including related to air and water quality. Verifiers should contact the applicable government agencies.	Every verification
Environmental Safeguard 2 – Mitigation of Pollutants	Historical records and ongoing monitoring and reporting through data logging of physical measurements, online sources, and government data to demonstrate the project was designed and implemented to mitigate potential releases of pollutants that may cause degradation of the quality of soil, air, surface and groundwater, and project developers have acquired the appropriate local permits prior to installation to prevent violation of all applicable laws. Verifiers should contact the applicable government agencies.	Every verification
Environmental Safeguard 3 – Animal Welfare	Signed Attestation of Regulatory Compliance form attesting to be in material compliance with all applicable laws, including related to animal welfare. Verifiers should contact the National Service of Health and Quality of Agricultural Foods (SENASA) and/or other applicable government agencies.	Every verification

## 8.4 Core Verification Activities

The Argentina Livestock Protocol provides explicit requirements and guidance for quantifying the GHG reductions associated with installing a BCS to capture and destroy methane gas from livestock operations. The Verification Program Manual describes the core verification activities that shall be performed by verification bodies for all project verifications. They are summarized below in the context of a livestock project, but verification bodies must also follow the general guidance in the Verification Program Manual.

Verification is a risk assessment and data sampling effort designed to ensure that the risk of reporting error is assessed and addressed through appropriate sampling, testing, and review. The three core verification activities are:

1. Identifying emission sources, sinks, and reservoirs
2. Reviewing GHG management systems and estimation methodologies
3. Verifying emission reduction estimates

### Identifying emission sources, sinks, and reservoirs

The verification body reviews for completeness the SSRs identified for a project, such as energy use waste collection and transport, treatment and storage, and uncombusted methane from the biogas control system.

### **Reviewing GHG management systems and estimation methodologies**

The verification body reviews and assesses the appropriateness of the methodologies and management systems that the livestock project operator uses to gather data and calculate baseline and project emissions.

### **Verifying emission reduction estimates**

The verification body further investigates areas that have the greatest potential for material misstatements and then confirms whether or not material misstatements have occurred. This involves site visits to the project to ensure the systems on the ground correspond to and are consistent with data provided to the verification body. In addition, the verification body recalculates a representative sample of the performance or emissions data for comparison with data reported by the project developer in order to double-check the calculations of GHG emission reductions.

## **8.5 Verification Period**

Per Section 7.3, this protocol provides project developers three verification options for a project after its initial verification and registration in order to provide flexibility and help manage verification costs associated with livestock projects. The different options require verification bodies to confirm additional requirements specific to this protocol, and in some instances, to utilize professional judgment on the appropriateness of the option selected.

### **8.5.1 Option 1: Twelve-Month Maximum Verification Period**

Option 1 does not require verification bodies to confirm any additional requirements beyond what is specified in the protocol.

### **8.5.2 Option 2: Twelve-Month Verification Period with Desktop Verification**

Option 2 requires verification bodies to review the documentation specified in Section 6 in order to determine if a desktop verification is appropriate. The verifier shall use his/her professional judgment to assess any changes that have occurred related to a project's data management systems, equipment, or personnel and determine whether a site visit should be required as part of verification activities in order to provide a reasonable level of assurance on the project's verification. The documentation shall be reviewed prior to the COI/NOVA renewal being submitted to the Reserve, and the verification body shall provide a summary of its assessment and decision on the appropriateness of a desktop verification when submitting the COI/NOVA renewal. The Reserve reserves the right to review the documentation provided by the project developer and the decision made by the verification body on whether a desktop verification is appropriate.

### **8.5.3 Option 3: Twenty-Four Month Maximum Verification Period**

Under Option 3 (see Section 7.3.4), verification bodies shall look to the project Monitoring Report submitted by the project developer to the Reserve for the interim 12 month reporting period as a resource to inform its planned verification activities. Verification bodies will need to provide a reasonable level of assurance about the accuracy of the Monitoring Report as part of

the verification, the verification body shall list a summary of discrepancies between the Monitoring Report and what was ultimately verified in the List of Findings.

## 8.6 Livestock Verification Items

The following tables provide lists of items that a verification body needs to address while verifying a livestock project. The tables include references to the section in the protocol where requirements are further specified. The table also identifies items for which a verification body is expected to apply professional judgment during the verification process. Verification bodies are expected to use their professional judgment to confirm that protocol requirements have been met in instances where the protocol does not provide (sufficiently) prescriptive guidance. For more information on the Reserve's verification process and professional judgment, please see the Verification Program Manual.

**Note: These tables shall not be viewed as a comprehensive list or plan for verification activities, but rather guidance on areas specific to livestock projects that must be addressed during verification.**

### 8.6.1 Project Eligibility and CRT Issuance

Table 8.2 lists the criteria for reasonable assurance with respect to eligibility and CRT issuance for livestock projects. These requirements determine if a project is eligible to register with the Reserve and/or have CRTs issued for the verification period. If any requirement is not met, either the project may be determined ineligible or the GHG reductions from the reporting period (or sub-set of the reporting period) may be ineligible for issuance of CRTs, as specified in Sections 2, 3, and 6.

**Table 8.2.** Eligibility Verification Items

Protocol Section	Eligibility Qualification Item	Apply Professional Judgment?
2.1	Verify that the project meets the definition of a livestock project	No
2.2	Verify ownership of the reductions by reviewing Attestation of Title and other relevant contracts, documentation	No
2.2	If the livestock facility operates as a "hotelería," verify that a sample of the contracts with the livestock owners establish GHG emission reduction rights.	Yes
3.2	Verify eligibility of project start date	No
3.2	Verify accuracy of project start date based on operational records	Yes
3.3	Verify that project is within its 10-year crediting period	No
3.4	Verify that all pre-project manure treatment lagoons/ponds/tanks were of sufficient depth to ensure an oxygen free bottom layer (> 1m)	Yes
3.4	If the project is a Greenfield project at a new livestock facility, verify that uncontrolled anaerobic treatment is common practice for the industry in the geographic region where the project is located	Yes



Protocol Section	Eligibility Qualification Item	Apply Professional Judgment?
3.5.1	Verify that the project meets the Performance Standard Test	No
3.5.2	Confirm execution of the Attestation of Voluntary Implementation form to demonstrate eligibility under the Legal Requirement Test	No
3.6	Verify that the project activities comply with applicable laws by reviewing instances of non-compliance provided by the project developer and performing a risk-based assessment to confirm the statements made by the project developer in the Attestation of Regulatory Compliance form	Yes
3.7	Verify that the project developer complied with the social and environmental safeguard. Confirm with the farm owner and/or landowner that the project developer conducted FPIC requirements. Review that the Attestation of No Conflict was signed and submitted to the Reserve.	Yes
6	Verify that monitoring meets the requirements of the protocol. If it does not, verify that variance has been approved for monitoring variations	No
6	Verify that all gas flow meters and continuous methane analyzers adhered to the inspection, cleaning, and calibration schedule specified in the protocol. If they do not, verify that a variance has been approved for monitoring variations or that adjustments have been made to data per the protocol requirements	No
6	Verify that adjustments for failed calibrations were properly applied	No
6, Appendix D	If used, verify that data substitution methodology was properly applied	No

### 8.6.2 Quantification

Table 8.3 lists the items that verification bodies shall include in their risk assessment and re-calculation of the project's GHG emission reductions. These quantification items inform any determination as to whether there are material and/or immaterial misstatements in the project's GHG emission reduction calculations. If there are material misstatements, the calculations must be revised before CRTs are issued.

**Table 8.3.** Quantification Verification Items

Protocol Section	Quantification Item	Apply Professional Judgment?
4	Verify that all SSRs in the GHG Assessment Boundary are accounted for	No
5	Verify that the modeled baseline is compared with the total amount of methane metered and destroyed by the project, and the lesser of the two values is used as the baseline for the GHG reduction calculation	No
5.1	Verify that the livestock categories (L) are correctly differentiated	Yes

Protocol Section	Quantification Item	Apply Professional Judgment?
5.1	Verify that the project developer applied the correct VS and B <sub>0</sub> values for each livestock category	No
5.1	Verify that the fraction of manure (MS) handled by the different manure management system components (i.e., GHG source) is satisfactorily represented	Yes
5.1	Verify that the project developer used methane conversion factors (MCF) differentiated by temperature	No
5.1	Verify that the methane baseline emissions calculations for each livestock category were calculated according to the protocol with the appropriate data	No
5.1	Verify that the project developer correctly aggregated methane emissions from sources within each livestock category	Yes
5.4	Verify that the project developer correctly monitored, quantified and aggregated electricity use	Yes
5.2, 5.4	Verify that the project developer correctly monitored, quantified and aggregated fossil fuel use	Yes
5.2, 5.4	Verify that the project developer applied the correct emission factors for fossil fuel combustion and grid-delivered electricity	No
5.2	Verify that the project developer applied the correct methane destruction efficiencies	No
5.2	Verify that the project developer correctly quantified the amount of uncombusted methane	No
5.2	Verify that methane emissions resulting from any venting event are estimated correctly	Yes
5.2	Verify that the correct MCF factor was used for the effluent storage pond	No
5.2, 5.4	Verify that the project emissions calculations were calculated according to the protocol with the appropriate data	No
5.2, 5.1	Verify that the project developer assessed baseline and project emissions on a month-to-month basis	No
5.2	Verify that the project developer correctly monitored and quantified the amount of methane destroyed by the project	No
5.3.3	Verify that the modeled methane emission reductions are compared with the <i>ex-post</i> methane metered and destroyed by the project, and the lesser of the two values is used to quantify project emission reductions	No

### 8.6.3 Risk Assessment

Verification bodies will review the following items in Table 8.4 to guide and prioritize their assessment of data used in determining eligibility and quantifying GHG emission reductions.

**Table 8.4.** Risk Assessment Verification Items

Protocol Section	Item that Informs Risk Assessment	Apply Professional Judgment?
6	Verify that the project Monitoring Plan is sufficiently rigorous to support the requirements of the protocol and proper operation of the project	Yes
6	Verify that the BCS was operated and maintained according to manufacturer specifications	No
6	Verify that appropriate monitoring equipment is in place to meet the requirements of the protocol	No
6	Verify that the individual or team responsible for managing and reporting project activities are qualified to perform this function	Yes
6	Verify that appropriate training was provided to personnel assigned to greenhouse gas reporting duties	Yes
6	Verify that all contractors are qualified for managing and reporting greenhouse gas emissions if relied upon by the project developer. Verify that there is internal oversight to assure the quality of the contractor's work	Yes
7.2	Verify that all required records have been retained by the project developer	No

## 8.7 Completing Verification

The Verification Program Manual provides detailed information and instructions for verification bodies to finalize the verification process. It describes completing a Verification Report, preparing a Verification Opinion, submitting the necessary documents to the Reserve, and notifying the Reserve of the project's verified status.

## 9 Glossary of Terms

Additionality	Manure management practices that are above and beyond business-as-usual operation, exceed the baseline characterization, and are not mandated by local regulations.
Anaerobic	Pertaining to or caused by the absence of oxygen.
Anthropogenic emissions	GHG emissions resultant from human activity that are considered to be an unnatural component of the carbon cycle (i.e., fossil fuel combustion, deforestation etc.).
Biogas	The mixture of gas (largely methane) produced as a result of the anaerobic decomposition of livestock manure.
Biogas control system (BCS)	A system designed to capture and destroy the biogas that is produced by the anaerobic treatment and/or storage of livestock manure and/or other organic material. Commonly referred to as a “digester.”
Biogenic CO <sub>2</sub> emissions	CO <sub>2</sub> emissions resulting from the combustion and/or aerobic decomposition of organic matter. Biogenic emissions are considered to be a natural part of the carbon cycle, as opposed to anthropogenic emissions.
Carbon dioxide (CO <sub>2</sub> )	The most common of the six primary greenhouse gases, consisting of a single carbon atom and two oxygen atoms.
Clean Development Mechanism (CDM)	One of the three flexible mechanisms established by the Kyoto Protocol. CDM is the market instrument in which certified emission reductions can be achieved from a project developed in a “non-Annex I” country (developing country) with the assistance of an “Annex I” country (industrialized country). These reductions are accrued to the reduction commitment of the “Annex I” party (Art. 12 of the Kyoto Protocol) in the Kyoto Protocol’s first commitment period (2008-2012).
CO <sub>2</sub> equivalent (CO <sub>2</sub> e)	The quantity of a given GHG multiplied by its total global warming potential. This is the standard unit for comparing the degree of warming which can be caused by different GHGs.
Direct emissions	Greenhouse gas emissions from sources that are owned or controlled by the reporting entity.

Emission factor	A unique value for determining an amount of a greenhouse gas emitted for a given quantity of activity data (e.g., metric tons of carbon dioxide emitted per barrel of fossil fuel burned).
Flare	A destruction device that uses an open flame to burn combustible gases with combustion air provided by uncontrolled ambient air around the flame.
Fossil fuel	A fuel, such as coal, oil, and natural gas, produced by the decomposition of ancient (fossilized) plants and animals.
Greenhouse gas (GHG)	Means carbon dioxide (CO <sub>2</sub> ), methane (CH <sub>4</sub> ), nitrous oxide (N <sub>2</sub> O), sulfur hexafluoride (SF <sub>6</sub> ), hydrofluorocarbons (HFCs) or perfluorocarbons (PFCs).
GHG reservoir	A physical unit or component of the biosphere, geosphere or hydrosphere with the capability to store or accumulate a GHG that has been removed from the atmosphere by a GHG sink or captured from a GHG source.
GHG sink	A physical unit or process that removes GHG from the atmosphere.
GHG source	A physical unit or process that releases GHG into the atmosphere.
Global Warming Potential (GWP)	The ratio of radiative forcing (degree of warming to the atmosphere) that would result from the emission of one unit of a given GHG compared to one unit of CO <sub>2</sub> .
<i>Hotelería</i>	Livestock operations common in Argentina that raise third-party livestock for a fee.
Indirect emissions	Emissions that are a consequence of the actions of a reporting entity, but are produced by sources owned or controlled by another entity.
Livestock	Domesticated animals raised in an agricultural setting. The Protocol specifically is referring to dairy cattle, beef cattle, and swine.

Livestock project	Installation of a biogas control system that, in operation, causes a decrease in GHG emissions from the baseline scenario through destruction of the methane component of biogas.
Metric ton (MT or tonne)	A common international measurement for the quantity of GHG emissions, equivalent to about 2204.6 pounds or 1.1 short tons.
Methane (CH <sub>4</sub> )	A potent GHG, consisting of a single carbon atom and four hydrogen atoms.
MMBtu	One million British thermal units.
Mobile combustion	Emissions from the transportation of materials, products, waste, and employees resulting from the combustion of fuels in company owned or controlled mobile combustion sources (e.g., cars, trucks, tractors, dozers, etc.).
Nitrous oxide (N <sub>2</sub> O)	A potent GHG, consisting of two nitrogen atoms and a single oxygen atom.
Project baseline	A business-as-usual GHG emission assessment against which GHG emission reductions from a specific GHG reduction activity are measured.
Project developer	An entity that undertakes a project activity, as identified in the Argentina Livestock Project Protocol. A project developer may be an independent third party or the dairy/swine operating entity.
Reporting period	The period of time over which a project developer quantifies and reports GHG reductions to the Reserve. Under this protocol, the reporting period cannot exceed 12 months.
Stationary combustion source	A stationary source of emissions from the production of electricity, heat, or steam, resulting from combustion of fuels in boilers, furnaces, turbines, kilns, and other facility equipment.

---

van't Hoff-Arrhenius factor	The proportion of volatile solids that are biologically available for conversion to methane based on the monthly temperature of the system. <sup>61</sup>
Verification	The process used to ensure that a given participant's greenhouse gas emissions or emission reductions have met the minimum quality standard and complied with the Reserve's procedures and protocols for calculating and reporting GHG emissions and emission reductions.
Verification body	A Reserve accredited firm that is able to render a verification opinion and provide verification services for operators subject to reporting under this protocol.
Verification period	The period of time over which GHG reductions are verified. Under this protocol, a verification period may cover multiple reporting periods (see Section 7.3). The end date of any verification period must correspond to the end date of a reporting period.

---

<sup>61</sup> Mangino, et al.

## 10 References

American Society of Agricultural Engineers, Standard: ASAE D384.2 (2005).

Association of State Energy Research and Technology Transfer Institutions (ASERTTI), US Environmental Protection Agency AgStar Program, and US Department of Agriculture Rural Development, Protocol for Quantifying and Reporting the Performance of Anaerobic Digestion Systems for Livestock Manures ( January 2007).

Intergovernmental Panel on Climate Change, Good Practice Guidance and Uncertainty Management in National Greenhouse Gas Inventories (2001).

Intergovernmental Panel on Climate Change, IPCC Guidelines for National Greenhouse Gas Inventories, Chapter 10: Emissions from Livestock and Manure Management (2006).

Intergovernmental Panel on Climate Change, IPCC Guidelines for National Greenhouse Gas Inventories, Chapter 11: N<sub>2</sub>O Emissions from Managed Soils, and CO<sub>2</sub> Emissions from Lime and Urea Application (2006).

Mangino, J., Bartram, D. y Brazy, A. Development of a methane conversion factor to estimate emissions from animal waste lagoons. Presentado en la 17<sup>o</sup> Conferencia Annual de Inventarios de Emisiones de la EPA estadounidense, Atlanta GA, del 16 al 18 de abril de 2001. National Institute of Innovation and Transfer in Agricultural Technology (2017) Management manual: intensive sustainable fattening livestock systems, Costa Rica.

Ministry of Environment and Natural Resources, National Council for Climate Change and Clean Development Mechanism and United Nations Development Program (2020).

Seebold, J.G., et. Al., Reaction Efficiency of Industrial Flares: The Perspective of the Past (2003).

Solid Waste Association of North America, Landfill gas operation and maintenance, manual of practice (1997).

U.S. Department of Agriculture Natural Resources Conservation Service, Conservation Practice Standard, Anaerobic Digester—Controlled Temperature, No. 366.

U.S. Department of Agriculture Natural Resources Conservation Service, Conservation Practice Standard, Waste Storage Facility, No. 313.

U.S. Department of Agriculture Natural Resources Conservation Service, Conservation Practice Standard, Waste Treatment Lagoon, No. 359.

U.S. Department of Energy 1605(b) Technical Guidelines for Voluntary Reporting of Greenhouse Gas Program.



U.S. Department, of Agriculture Natural Resources Conservation Service, Conservation Practice Standard, Anaerobic Digester—Ambient Temperature, No. 365.

U.S. Environmental Protection Agency - Climate Leaders, Draft Manure Offset Protocol, (October 2006).

U.S. Environmental Protection Agency, Inventory of U.S. Greenhouse Gas Emissions and Sinks: 1990-2002, 1990-2003, 1990-2004, 1990-2005, y 1990-2006.

United Nations Framework Convention on Climate Change (UNFCCC), Revisions to the Approved Consolidated Baseline Methodology ACM0010, “Consolidated baseline methodology for greenhouse gas emission reductions from manure management systems,” Clean Development Mechanism, Version 02, Sectoral Scopes 13 and 15 (2006).

World Resource Institute and World Business Council for Sustainable Development, Greenhouse Gas Protocol for Project Accounting (November 2005)

## Appendix A Associated Environmental and Social Impacts

Manure management projects have many documented environmental benefits, including air emission reductions, water quality protection, and electricity generation. These benefits are the result of practices and technologies that are well managed, well implemented, and well designed. However, in cases where practices or technologies are poorly or improperly designed, implemented, and/or managed, local air and water quality could be compromised.

With regard to air quality, there are a number of factors that must be considered and addressed to realize the environmental benefits of a biogas project and reduce or avoid potential negative impacts. Uncontrolled emissions from combustion of biogas may contain between 200 to 300 ppm NO<sub>x</sub>. The anaerobic treatment process creates intermediates such as ammonia, hydrogen sulfide, orthophosphates, and various salts, all of which must be properly controlled or captured.

In addition, atmospheric releases at locations off-site where biogas is shipped may negate or decrease the benefit of emissions controls on-site. Thus, while devices such as Selective Catalyst Reduction (SCR) units can reduce NO<sub>x</sub> emissions and proper treatment system operation can control intermediates, improper design or operation may lead to violations of national, provincial, and local air quality regulations as well as release of toxic air contaminants.

With regard to water quality, it is critical that project developers and managers ensure digester integrity and fully consider and address post-digestion management of the effluent in order to avoid contamination of local waterways and groundwater resources. Catastrophic digester failures; leakage from pipework and tanks; and lack of containment in waste storage areas are all examples of potential problems. Further, application of improperly treated digestate and/or improper application timing or rates of digestate to agricultural land may lead to increased nitrogen oxide emissions, soil contamination, and/or nutrient leaching, thus negating or reducing benefits of the project overall.

Project developers must not only follow the protocol to register GHG reductions with the Reserve, they must also comply with all local, state, and national air and water quality regulations. Projects must be designed and implemented to mitigate potential releases of pollutants such as those described, and project managers must acquire the appropriate local permits prior to installation to prevent violation of the law.

The Reserve agrees that GHG emission reduction projects should not undermine air and water quality efforts and will work with stakeholders to establish initiatives to meet both climate-related and localized environmental objectives.

### A.1 Environmental Regulations in Argentina

At the national level, Argentina has the General Environmental Law No. 25,675 establishes the minimum budgets for achieving sustainable and adequate management of the environment, the preservation and protection of biological diversity, and the implementation of sustainable development in Argentina. Likewise, it establishes a general framework on information and participation in environmental matters, responsibility for environmental damage and environmental education.

Similarly, Law No. 25,612 (July 25, 2002) establishes the minimum budgets for environmental protection on the comprehensive management of industrial waste and service activities. However, due to disagreement with the risk assessment procedure from the Federal Environmental Council, the law is not currently in effect.

Law No. 23,922 that approves the Basel Convention on the Control of Transborder Movements of Hazardous Waste and their Disposal, states that the State parties should undertake appropriate measures to reduce the generation of waste and minimize its impact on human health and the environment. What constitutes hazardous waste and its management is established by Law No. 24,051. According to this standard, any waste that can cause harm, directly or indirectly, to living beings or contaminate the soil, water, atmosphere, or environment in general is called hazardous. It includes those infectious substances that contain viable microorganisms or their toxins, agents or cases of diseases in animals or people.

Regarding gaseous emissions, they are regulated by the Law on Atmospheric Pollution No. 20,284, which establishes the provisions for the care of air resources, including sources capable of producing atmospheric pollution. This regulation establishes the maximum permitted gases: Carbon Monoxide (CO), Nitrogen Oxides (SOx), Sulfur Dioxide (SO<sub>2</sub>), Ozone (O<sub>3</sub>), suspended particles, and settleable particles.

On the other hand, in the Instrumental Provisions for the application of Decree No. 674/89 Regulatory of Articles 31, 32 and 34 of Law No. 13,577 related to the Sanitary Works of the Nation, provides the permissible limits of discharge to the sewage collection systems, storm drains, and water courses.

In the Province of Córdoba, any new intensive breeding establishment that wants to be established must present an Environmental Impact Assessment. However, they are not legally required to reduce their GHG emissions.

Provincial Resolution 29/17 provides livestock operators with the tools to facilitate the management of this Livestock Waste through stabilization treatments that allow it to be reused as an organic amendment. The Resolution suggests that liquid effluents are stabilized in waterproofed lagoons and require a minimum residence time of 120 days, when they come directly from the raw material pit, or 90 days, when they come from a biodigester. However, does not mandate the use of a biodigester, nor the reuse of livestock waste.

Resolution 105/17 sets the environmental standards for Air Emissions from productive activities in Córdoba to protect public health. The Environmental Standards for Air Quality and Emissions Control establish permissible limits for thirteen pollutants – such as SO<sub>2</sub>, NO<sub>2</sub>, and ozone – present in gaseous effluents for new industrial sources, but do not include CO<sub>2</sub> or CH<sub>4</sub>.

Additional national and provincial environmental regulations are available at <https://ambiente.cba.gov.ar/normativa-ambiental/>, [www.infoleg.gob.ar](http://www.infoleg.gob.ar), and <https://www.crea.org.ar/mapalegal/>. The discussion of regulations above should not be considered a complete list of regulations. The project monitoring plan will include the procedures that the project developer will follow to verify and demonstrate that the project is in compliance at all times.

## A.2 Political Regulations with a Social Impact in Argentina

The National Registry of Rural Workers (RENATRE) is the national regulatory agency overseeing compliance with agricultural worker safety laws and regulations.

Law 26,727 Agricultural Work Regime<sup>62</sup> was established by the Ministry of Justice of the Nation to ensure that agricultural workers have favorable working conditions, and that employment contracts and compensation requirements are fulfilled.

National Law 19.587 - Safety and Hygiene at Work and its Regulatory Decrees 351/79 and 1338/96 determine the technical standards and safety, sanitary, precautionary, protection or any other kind of measures that aim to:

- a. protect the life, preserve, and maintain the psychophysical integrity of workers;
- b. prevent, reduce, eliminate, or isolate the risks of the different work centers or jobs;
- c. to stimulate and develop a positive attitude towards the accidents prevention or illnesses that may arise from work activities.

Decree 617/97, The Hygiene and Safety Regulations for Agricultural Activity<sup>63</sup> under Article 5 establishes the obligation for agricultural workers to have occupational health and safety and medical services, with the modalities determined by the occupational risk superintendence.

---

<sup>62</sup> Law 26,727 Agricultural Work Regime available on <https://www.argentina.gob.ar/normativa/nacional/17612/texto>

<sup>63</sup> Decree 617/97, The Hygiene and Safety Regulations for Agricultural Activity available on <https://servicios.infoleg.gob.ar/infolegInternet/anexos/40000-44999/44408/texact.htm>

## Appendix B Emission Factor Tables

**Table B.1.** Manure Management System Components

System	Definition
Pasture/Range/Paddock	The manure from pasture and range grazing animals is allowed to lie as deposited, and is not managed.
Daily spread	Manure is routinely removed from a confinement facility and is applied to cropland or pasture within 24 hours of excretion.
Solid storage	The storage of manure, typically for a period of several months, in unconfined piles or stacks. Manure is able to be stacked due to the presence of a sufficient amount of bedding material or loss of moisture by evaporation.
Solid storage – Covered/compacted	Similar to solid storage, but the manure pile is a) covered with a plastic sheet to reduce the surface of manure exposed to air and/or b) compacted to increase the density and reduce the free air space within the material.
Solid storage – Bulking agent addition	Specific materials (bulking agents) are mixed with the manure to provide structural support. This allows the natural aeration of the pile, thus enhancing decomposition. (e.g., sawdust, straw, coffee husks, maize stover).
Solid storage – Additives	The addition of specific substances to the pile in order to reduce gaseous emissions. Addition of certain compounds such as attapulgite, dicyandiamide or mature compost have shown to reduce N <sub>2</sub> O emissions; while phosphogypsum reduces CH <sub>4</sub> emissions.
Dry lot	A paved or unpaved open confinement area without any significant vegetative cover where accumulating manure may be removed periodically.
Liquid/Slurry	Manure is stored as excreted or with some minimal addition of water or bedding material in tanks or ponds outside the animal housing. Manure is removed and spread on fields once or more in a calendar year. Manure is agitated before removal from the tank/ponds to ensure that most of the VS are removed from the tank.
Uncovered anaerobic lagoon	A type of liquid storage system designed and operated to combine waste stabilization and storage. Lagoon supernatant is usually used to remove manure from the associated confinement facilities to the lagoon. Anaerobic lagoons are designed with varying lengths of storage (up to a year or greater), depending on the climate region, the volatile solids loading rate, and other operational factors. The water from the lagoon may be recycled as flush water or used to irrigate and fertilize fields.
Pit storage below animal confinements	Collection and storage of manure usually with little or no added water typically below a slatted floor in an enclosed animal confinement facility, usually for periods less than one year. Manure may be pumped out of the storage to a secondary storage tank multiple times in one year or stored and applied directly to fields. It is assumed that VS removal rates on tank emptying are >90%.

System		Definition
Anaerobic digester	Digesters of high quality and low leakage	Animal manure with and without straw is collected and anaerobically digested in a containment vessel. Co-digestion with other waste or energy crops may occur. Digesters are designed, constructed and operated according to industrial technology standard for waste stabilization by the microbial reduction of complex organic compounds to CO <sub>2</sub> and CH <sub>4</sub> . Biogas is captured and used as a fuel. Digestate is stored either in open storage, in covered storage with no leakage control, or in gas tight storage with gas recovery or flaring.
	Digesters with high leakage	Animal manure with and without straw is collected and anaerobically digested in covered lagoon. Digesters are used for waste stabilization by the microbial reduction of complex organic compounds to CO <sub>2</sub> and CH <sub>4</sub> . Biogas is captured and flared or used as a fuel. After anaerobic digestion, digestate is stored either openly, covered, or gas tightly.
Burned for fuel		The dung and urine are excreted on fields. The sun dried dung cakes are burned for fuel.
Cattle and Swine deep bedding		As manure accumulates, bedding is continually added to absorb moisture over a production cycle and possibly for as long as 6 to 12 months. This manure management system also is known as a bedded pack manure management system and may be combined with a dry lot or pasture. Manure may undergo periods where animals are present and are actively mixing the manure, or periods in which the pack is undisturbed.
Composting	In-vessel*	Composting, typically in an enclosed channel, with forced aeration and continuous mixing
	Static pile	Composting in piles with forced aeration but no mixing.
	Intensive windrow*	Composting in windrows with regular (at least daily) turning for mixing and aeration.
	Passive windrow*	Composting in windrows with infrequent turning for mixing and aeration.
Aerobic treatment		The biological oxidation of manure collected as a liquid with either forced or natural aeration. Natural aeration is limited to aerobic and facultative ponds and wetland systems and is due primarily to photosynthesis. Hence, these systems typically become anoxic during periods without sunlight.

\*Composting is the biological oxidation of a solid waste including manure usually with bedding or another organic carbon source typically at thermophilic temperatures produced by microbial heat production.

Source: 2019 Refinement to the 2006 IPCC Guidelines for National Greenhouse Gas Inventories, Chapter 10: Emissions from Livestock and Manure Management, Table 10.18: Definitions of Manure Management Systems, p. 10.72.

**Table B.2.** Livestock Categories and Typical Average Mass

Livestock Category (L)	Livestock Typical Average Mass (kg)
<b>Dairy Cattle</b>	
Lactating and non-lactating Dairy Cow	580
Cow	546
Steer	450
Heifer	439
Bull	680
Calf	230
<b>Beef Cattle</b>	
Cow	431
Calf	188
Heifer	349
Castrated or Immuno-castrated Calves	209
Castrated Steer	387
Immuno-castrated Steer	434
<b>Swine</b>	
Sow (Pregnant, Lactating, or Empty)	250
Sucking Piglet	8
Post-Weaning – Initial	8
Post-Weaning – Final	30
Growing Pigs – Initial	30
Growing Pigs – Final	60
Finished	115
Stallion	250
Immuno-Castrated Male	115
Replacement Swine	130
Capon <sup>64</sup>	115
Cull Sow <sup>65</sup>	250

**Source:** Estimated values from the Livestock Secretariat of the Ministry of Agriculture and Livestock of the Province of Cordoba, Argentina. The workgroup confirmed that livestock categories from Córdoba Province are conservative and representative of the country.<sup>66</sup>

<sup>64</sup> Castrated male pigs intended for slaughter

<sup>65</sup> Type of sows that are culled (killed humanely on farms) from the farm because they are too old or because they suffer certain problems that make have a low productivity.

<sup>66</sup> Refer to Workgroup meetings and notes for additional information. Available on <https://www.climateactionreserve.org/how/protocols/waste/argentina-livestock-protocol/dev/>

**Table B.3.** Volatile Solids and Maximum Methane Potential by Livestock Category

Livestock category (L)	VS <sub>L</sub> (kg/head/day)	B <sub>0,L</sub> <sup>c</sup> (m <sup>3</sup> CH <sub>4</sub> /kg VS)
<b>Beef cattle</b>		
Cow	1.701 <sup>a</sup>	0.13
Heifer	1.341 <sup>a</sup>	0.13
Calf	0.675 <sup>a</sup>	0.13
Small Bull	1.143 <sup>a</sup>	0.13
Steer	2.171 <sup>a</sup>	0.13
Bull	1.795 <sup>a</sup>	0.13
<b>Dairy cattle</b>		
Cow	3.777 <sup>a</sup>	0.13
Heifer	1.593 <sup>a</sup>	0.13
Calf	1.160 <sup>a</sup>	0.13
Steer	1.620 <sup>a</sup>	0.13
Bull	1.757 <sup>a</sup>	0.13
<b>Swine</b>		
Breeding	0.14 <sup>b</sup>	0.29
Fattening 1 (23-57kg)	0.25 <sup>b</sup>	0.29
Fattening 2 (57-80kg)	0.33 <sup>b</sup>	0.29
Fattening 3 (80-114kg)	0.39 <sup>b</sup>	0.29
Suckling pigs	0.33 <sup>b</sup>	0.29
Stallions	0.31 <sup>b</sup>	0.29
Gestation sow	0.30 <sup>b</sup>	0.29
Maternity sow + piglets	1.05 <sup>b</sup>	0.29

<sup>a</sup> Estimates based on the parameters provided from the methodology used in GLEAM-i, a tool developed by FAO in conjunction with the World Bank and the International Finance Corporation.

<sup>b</sup> Ministry of Agroindustry, Presidency of the Nation (2016), Good Management Practices and Use of Swine Effluents

<sup>c</sup> Default values for Latin America. Source: 2019 Refinement to the 2006 IPCC Guidelines for National Greenhouse Gas Inventories, Volume 4, Chapter 10, Section 10.4.2 (Table 10.16a). This table uses B<sub>0,L</sub> values for beef cattle (non-dairy) and dairy cattle categorized as "other region" low productivity systems by the IPCC.



**Table B.4.** IPCC 2019 Methane Conversion Factors by Manure Management System Component/Methane Source ‘S’<sup>67</sup>

Methane Conversion Factors by Climate Zone for Manure Management Systems											
System <sup>a</sup>	MCF by Climate Zone										Source and Comments
	Cool				Temperate		Warm				
	Cool Temperate Moist	Cool Temperate Dry	Boreal Moist	Boreal Dry	Warm Temperate Moist	Warm Temperate Dry	Tropical Montane	Tropical Wet	Tropical Moist	Tropical Dry	
Pasture/Range/ Paddock	0.47%										Pasture Range and Paddock MCFs must always be used in conjunction with a B0 value of 0.19 m <sup>3</sup> CH <sub>4</sub> /kg of VS excreted to maintain consistency with the data in updated version of Cai et al. (2017) database (see Annex 10B.6 of the IPCC 2019 Refinement to the 2006 IPCC Guidelines for Greenhouse Gas Inventories)
Daily spread	0.10%				0.50%		1.00%				Hashimoto & Steed (1993)

<sup>67</sup> From IPCC 2019 Refinement to the 2006 IPCC Guidelines for Greenhouse Gas Inventories, Chapter 10: Emissions from Livestock and Manure Management, Table 10.17. MCF values shall be chosen based on the temperature zone for where the livestock operation is located.

Solid storage	2.00%	4.00%	5.00%	Sources and assumptions to calculate MCF values for Solid storage categories and composting (static pile and passive windrows) are detailed in Annex 10B.7 of the IPCC 2019 Refinement to the 2006 IPCC Guidelines for Greenhouse Gas Inventories. Expert judgment based on IPCC (2006) and update supported by Pardo et al. (2015). Emissions in temperate climate can be double relative to a cool climate.
Solid storage - Covered/compacted	2.00%	4.00%	5.00%	Sources and assumptions to calculate MCF values for Solid storage categories and composting (static pile and passive windrows) are detailed in Annex 10B.7. of the IPCC 2019 Refinement to the 2006 IPCC Guidelines for Greenhouse Gas Inventories. Expert judgment based on Pardo et al., (2015). Emissions in the same range as solid storage.
Solid storage - Bulking agent additional	0.50%	1.00%	1.50%	Sources and assumptions to calculate MCF values

				for Solid storage categories and composting (static pile and passive windrows) are detailed in Annex 10B.7. of the IPCC 2019 Refinement to the 2006 IPCC Guidelines for Greenhouse Gas Inventories. Expert judgment based on Pardo et al. (2015). Estimated reduction of 75% due to bulking agent addition
Solid storage - Additives	1.00%	2.00%	2.50%	Sources and assumptions to calculate MCF values for Solid storage categories and composting (static pile and passive windrows) are detailed in Annex 10B.7 of the IPCC 2019 Refinement to the 2006 IPCC Guidelines for Greenhouse Gas Inventories. Expert judgment based on Pardo et al. (2015). Estimated reduction of 50% due to additives addition.
Poultry manure with and without litter	1.50%			Judgment of 2006 IPCC Expert Group. MCFs are similar to solid storage or to dry lot but with generally constant warm temperatures.

Aerobic treatment		0.00%										Judgment of 2006 IPCC Expert Group. MCFs are near zero. Aerobic treatment can result in the accumulation of sludge which may be treated in other systems. Sludge requires removal and has large VS values. It is important to identify the next management process for the sludge and estimate the emissions from that management process if significant.	
Dry lot		1.00%				1.50%			5.00%				Judgment of IPCC 2006 Expert Group in combination with Hashimoto & Steed (1993)
Liquid/ Slurry, and Pit storage below animal confinemen ts	1 month	6%	8%	4%	4%	13%	15%	25%	38%	36%	42%	The initial judgment of IPCC Expert Group supported by additional new research (See Annex B.7 of the IPCC 2019 Refinement to the 2006 IPCC Guidelines for Greenhouse Gas Inventories for additional details). Suggested default values are equivalent to liquid systems with 6 month retention time if retention times are unknown. A reduction of 40% due to crust cover	
	3 months	12%	16%	8%	8%	24%	28%	43%	61%	57%	62%		

	4 months	15%	19%	9%	9%	29%	32%	50%	67%	64%	68%	<p>may be applied only when a thick, dry, crust is present. Thick dry crusts occur in systems in which organic bedding is used in the barn and is allowed. For 3 months, the <math>T_{avg}</math> C for Cool Temperate Moist, Cool Temperate Dry, Warm Temperate Moist, Warm Temperate Dry, Tropical, Tropical Wet, Tropical Moist, Tropical Dry were 4.6, 5.8, 13.9, 14.0, 21.5, 25.9, 25.2, 25.6 respectively. For 4-12 months, solid-liquid separation that removes VS and diverts it to aerobic/solid management should be considered when calculating the VS loading rate into liquid systems.</p>
	6 months	21%	26%	14%	14%	37%	41%	59%	76%	73%	74%	
	12 months	31%	42%	21%	20%	55%	64%	73%	80%	80%	80%	
Uncovered anaerobic lagoon		60%	57%	50%	49%	73%	76%	76%	80%	80%	80%	<p>Judgment of IPCC Expert Group utilizing a 12 month retention time and the equations and parameters presented in Mangino et al. (2001). Solid-liquid separation that removes VS and diverts it to aerobic/solid management should be considered when calculating the VS loading rate into liquid systems</p>

Anaerobic digester	Low leakage, High quality gastight storage, best complete industrial technology	1.00%			Calculations based on Haenel et al (2018), outlined in Annex 10A.4 of the IPCC 2019 Refinement to the 2006 IPCC Guidelines for Greenhouse Gas Inventories.
	Low leakage, High quality industrial technology , low quality gastight storage technology	1.40%			
	Low leakage, High quality industrial technology , open storage	3.55%	4.38%	4.59%	

	High leakage, low quality technology , high quality gastight storage technology	9.59%			
	High leakage, low quality technology , low quality gastight storage technology	10.85%			
	High leakage, low quality technology , open storage	12.14%	12.97%	13.17%	
Burned for fuel		10.00%			Judgment of IPCC 2006 Expert Group in combination with Safley et al. (1992)
Cattle and Swine deep bedding	< 1 month	2.75%	6.50%	18.00%	Judgment of IPCC 2006 Expert Group in combination with Moller et al. (2004). Expect emissions to be similar, and possibly greater,

												than pit storage, depending on organic content and moisture content.
	> 1 month	21%	26%	14%	14%	37%	41%	59%	76%	73%	74%	Articles from which these values were derived were for cattle and swine, but for other animal production systems that use deep bedding these values are proposed to be used as surrogates. Suggested default values are equivalent to liquid systems with 6 month retention time. Judgment of IPCC 2006 Expert Group in combination with Mangino et al. (2001). Values are consistent with liquid systems. Values presented here are consistent with a 6 month retention time; however compilers should take into account country-specific retention times when possible.
Composting - In-vessel		0.50%										Judgment of IPCC 2006 Expert Group and Amon et al. (1998a). MCFs are less than half of solid storage. Not temperature dependant.



Composting - Static pile	1.00%	2.00%	2.50%	Sources and assumptions to calculate MCF values for Solid storage categories and composting (static pile and passive windrows) are detailed in Annex 10B.7. of the IPCC 2019 Refinement to the 2006 IPCC Guidelines for Greenhouse Gas Inventories. Expert judgment update based on Pardo et al. (2015). Estimated reduction of 50% compared to solid storage. Previously it was considered "Not temperature dependent" but now temperature influence has been considered
Composting - Intensive windrow	0.50%	1.00%	1.50%	Judgment of IPCC Expert Group and Amon et al. (1998a). MCFs are slightly less than solid storage. Less temperature dependent.
Composting - Passive windrow (infrequent turning)	1.00%	2.00%	2.50%	Sources and assumptions to calculate MCF values for Solid storage categories and composting (static pile and passive windrows) are detailed in Annex 10B.7. of the IPCC 2019 Refinement to the 2006 IPCC Guidelines for

				<p>Greenhouse Gas Inventories. Expert judgment update based on Pardo et al. (2015). Estimated reduction of 50% compared to solid storage. Previous MCFs have been modified as they could underestimate CH<sub>4</sub> emissions.</p>
--	--	--	--	--

<sup>a</sup> Definitions for manure management systems are provided in Table B.1

**Table B.5.** Emission Factor for Stationary and Mobile Combustion

Fuel	Emission Factors [kg CO <sub>2</sub> /GJ]
<b>Stationary Combustion <sup>a</sup></b>	
Crude oil	73.30
Natural gas liquids	64.20
Gasoline	69.30
Kerosene	71.90
Diesel	74.10
Residual fuel oil	77.40
Liquefied Petroleum Gas (LPG)	63.10
Naphtha	73.30
Lubricants	73.30
Petroleum coke	97.50
Coking coal	94.60
Bituminous coal	94.60
Sub-bituminous coal	96.10
Natural gas	56.10
Waste oils	73.30
<b>Mobile combustion <sup>b</sup></b>	
gasoline vehicles	69.3
Gas/Diesel Vehicles	74.1
Liquefied petroleum gas (LPG) vehicles	63.1
Compressed natural gas (CNG) vehicles	56.10
Liquefied natural gas (LNG) vehicles	56.10
Aircraft (kerosene)	71.90

<sup>a</sup> IPCC, 2006. *IPCC Guidelines for National Greenhouse Gas Inventories*, Volume 2, Chapter 2, Stationary Combustion, Table 2.5, pages 2.22-2.23. Note that there were no corrections made in the IPCC 2019 Refinement

<sup>b</sup> IPCC, 2006. *IPCC Guidelines for National Greenhouse Gas Inventories*, Volume 2, Chapter 3, Mobile Combustion, Table 3.2.1, page 3.16. Note that there were no corrections made in the IPCC 2019 Refinement

**Table B.6.** Fossil Fuel Net Calorific Values

Fuel	Net calorific value
Distributed gas	0.034727 GJ/m <sup>3</sup>
Natural gas (from well)	0.036099 GJ/m <sup>3</sup>
Liquid gas	0.024975 GJ/L
Diesel Oil	0.037949 GJ/L
Fuel Oil	0.003876 GJ/L
Gasoil	0.036073 GJ/L
Natural gasoline	0.03048 GJ/L
Kerosene	0.03516 GJ/L
Gasoline	0.03284 GJ/L
Motor gasoline	0.03145 GJ/L
Raw oil	0.03726 GJ/L
Lubricants	0.031652 GJ/L
Coking coal	0.03182 GJ/kg
Vegetable oils	0.034282 GJ/L

**Source:** Ministry of Energy and Mining, Presidency of the Nation, (2016), National Energy Balance

2015, Methodological document. Available at:

[https://www.energia.gob.ar/contenidos/archivos/Reorganizacion/informacion\\_del\\_mercado/publicaciones/energia\\_en\\_gral/balances\\_2016/documento-metodologico-balance-energetico-nacional-final-2015.pdf](https://www.energia.gob.ar/contenidos/archivos/Reorganizacion/informacion_del_mercado/publicaciones/energia_en_gral/balances_2016/documento-metodologico-balance-energetico-nacional-final-2015.pdf)

If available, the official source tested methane destruction efficiency shall be used in place of the default methane destruction efficiency. Otherwise, project developers have the option to use either the default methane destruction efficiencies provided, or the site-specific methane destruction efficiencies as provided by a provincial or local agency accredited source test service provider, for each of the combustion devices used in the project case performed on an annual basis.

**Table B.7. Biogas Destruction Efficiency Default Values by Destruction Device**

Biogas Destruction Device	Biogas Destruction Efficiency (BDE)*
Open Flare	0.96 <sup>a</sup>
Enclosed Flare	0.995 <sup>a,c</sup>
Lean-burn Internal Combustion Engine	0.936 <sup>a,b</sup>
Rich-burn Internal Combustion Engine	0.995 <sup>a,b</sup>
Boiler	0.98 <sup>a</sup>
Microturbine or large gas turbine	0.995 <sup>a</sup>
Upgrade and use of gas as CNG/LNG fuel	0.95 <sup>a</sup>
Upgrade and injection into natural gas pipeline	0.98 <sup>d</sup>

**Source:**

<sup>a</sup> IPCC 2006 Guidelines volume 4, chapter 10, p. 10.43. Note no changes in the 2019 IPCC Refinement Report.

<sup>b</sup> Seebold, J.G., et al., Reaction Efficiency of Industrial Flares, 2003

<sup>c</sup> The default destruction efficiencies for this source are based on a preliminary set of actual source test data provided by the Bay Area Air Quality Management District. Default destruction efficiency values are the lesser of the twenty fifth percentile of the data provided or 0.995. These default destruction efficiencies may be updated as more source test data is made available to the Reserve.

<sup>d</sup> Revised 1996 IPCC Guidelines for National Greenhouse Gas Inventories gives a standard value for the fraction of carbon oxidized for gas destroyed of 99.5% (Reference Manual, Table 1.6, page 1.29). It also gives a value for emissions from processing, transmission and distribution of gas which would be a very conservative estimate for losses in the pipeline and for leakage at the end user (Reference Manual, Table 1.58, page 1.121). These emissions are given as 118,000 kgCH<sub>4</sub>/PJ based on gas consumption, which is 0.6%. Leakage in the residential and commercial sectors is stated to be 0 to 87,000 kgCH<sub>4</sub>/PJ, which equates to 0.4%, and in industrial plants and power station the losses are 0 to 175,000 kg/CH<sub>4</sub>/PJ, which is 0.8%. These leakage estimates are compounded and multiplied. The methane destruction efficiency for landfill gas injected into the natural gas transmission and distribution system can now be calculated as the product of these three efficiency factors, giving a total efficiency of (99.5% \* 99.4% \* 99.6%) 98.5% for residential and commercial sector users, and (99.5% \* 99.4% \* 99.2%) 98.1% for industrial plants and power stations.

**Formula 1: MCF value for a covered liquid effluent storage system with additional effluent treatment**

		<u>Units</u>
$MCF_{ep} = \frac{\frac{CH_{4,meter,ep}}{BCE} (MCF_{add} \times B_{0,ep} \times 0.3 \times VS_{ep} \times 0.717 \times d)}{B_{0,ep} \times VS_{ep} \times 0.717 \times d}$		
<i>Where,</i>		
MCF <sub>ep</sub>	= Methane conversion factor for a covered liquid effluent storage system	fraction
CH <sub>4,meter,ep</sub>	= Total quantity of methane released (uncombusted) from the effluent storage system. Biogas flow and methane concentration must be metered according to the requirements of Section 6	kg CH <sub>4</sub>
BCE	= Biogas collection efficiency (BCE) (see guidance in Equation 5.8)	fraction
MCF <sub>add</sub>	= Methane conversion factor for the additional treatment of effluent after the covered liquid effluent storage system. Project developers shall use the MCF value that corresponds to the treatment system.	fraction
B <sub>0,ep</sub>	= Maximum methane producing capacity (of VS dry matter) (see guidance in Equation 5.9)	m <sup>3</sup> CH <sub>4</sub> /kg VS
0.3	= Default value representing the amount of VS that exits the covered liquid effluent storage system as a percentage of the VS entering the covered liquid effluent storage system	fraction
VS <sub>ep</sub>	= Volatile solid to covered liquid effluent storage system (see guidance in Equation 5.9)	kg/day
0.717	= Density of methane (1 atm, 0°C)	kg/m <sup>3</sup>
d	= Number of days in reporting period	days

## Appendix C Summary of the Performance Standard Analysis

The purpose of a performance standard is to establish a threshold that is significantly better than average GHG production for a specified service, which, if met or exceeded by a project developer, satisfies the criterion of “additionality”. The Reserve’s project protocol focuses on the following direct emission reduction activity: capturing and combusting methane from livestock manure management. Therefore, in this case the methane emissions correspond to GHG production, and manure treatment/storage correspond to the specified service.

The analysis to establish the performance standard evaluated Argentina-specific data on dairy and swine manure management systems. Ultimately, it recommended a practice-based/technology-specific GHG emissions performance standard – i.e., installation of a manure digester (or biogas control system, more generally defined). The summary of the performance standard analysis includes the following sections:

- Livestock industry in the Argentina
- GHG emissions from livestock manure management
- Evaluation of common manure management practices
- Recommendation for a performance threshold for livestock operations

### C.1 Livestock Industry in Argentina

#### Beef Production

Argentina has the highest per capita consumption of beef in the world, largely sourced from the country’s national production, demonstrating the importance of the livestock industry for the Argentine economy.<sup>68</sup> In a report released by the Ministry of Economy in 2021, 70% of beef production is consumed domestically.<sup>69</sup>

As seen in Figure C.1, the Central region (Buenos Aires, Córdoba, Entre Ríos, and Santa Fe) concentrates approximately 65% of the national bovine population.<sup>70</sup> Although certain areas of the national territory concentrated the production of beef cattle, a majority of the country’s provinces have some degree of production.

According to the data obtained by the National Agri-Food Health and Quality Service (SENASA)<sup>71</sup> for the year 2022, the province of Córdoba had 18,877 beef-producing

---

<sup>68</sup> Bolsa de Comercio De Rosario. (June 2, 2023). Weekly Markets Newsletter. Available at: <https://www.bcr.com.ar/es/print/pdf/node/99332>

<sup>69</sup> Ministry of Economy, Argentina. (December 2021). Value Chain Reports: Livestock and Meat. [https://www.argentina.gob.ar/sites/default/files/ficha\\_sectorial\\_carne\\_bovina\\_-\\_diciembre.2021.pdf](https://www.argentina.gob.ar/sites/default/files/ficha_sectorial_carne_bovina_-_diciembre.2021.pdf)

<sup>70</sup> Figure C.1. Map and bovine population density by province as of March 2020 were obtained from SENASA. Available at: <https://www.argentina.gob.ar/senasa/mercados-y-estadisticas/estadisticas/animal-estadisticas/bovinos/bovinos-y-bubalinos-sector-primario>

<sup>71</sup> Data for each Province available at:

[https://www.magyp.gob.ar/sitio/areas/bovinos/informacion\\_interes/informes/\\_archivos//000003=Caracterizaci%C3%B3n%20y%20movimientos%20de%20hacienda/000012=2022/000000\\_Caracterizaci%C3%B3n%20Provincial%202022.pdf](https://www.magyp.gob.ar/sitio/areas/bovinos/informacion_interes/informes/_archivos//000003=Caracterizaci%C3%B3n%20y%20movimientos%20de%20hacienda/000012=2022/000000_Caracterizaci%C3%B3n%20Provincial%202022.pdf)

establishments with the National Health Registry of Agricultural Producers (RENSPA).

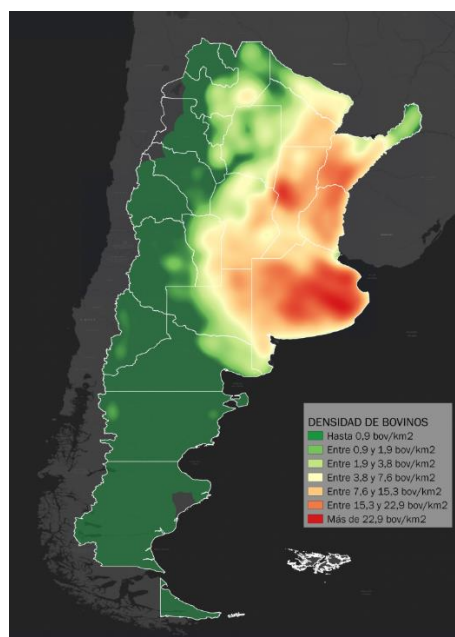

**Figure C.1.** Stock of beef cattle in Argentina

Small livestock operations (250 heads or fewer) make up 75% of the beef producers in the country, but only hold 22% of the total population. Whereas larger farms are only 5% of total operations and hold 40% of the beef cattle population.<sup>72</sup>

### Dairy Production

The production of milk and derivatives constitutes another relevant sector within national livestock production. Although the number of cattle dedicated to only dairy production is lower than meat production, this is one of the main productive activities in the central provinces.

According to the U.S. Department of Agriculture, there are 10,446 dairy farms in Argentina with milk production being concentrated in Córdoba (37%), Santa Fe (32%), and Buenos Aires (25%) (2021).<sup>73</sup> Dairy production in the province of Córdoba is mainly distributed in 3 basins or production areas, with 352 facilities in the South Basin, 1,608 facilities in the Northwest Basin, and 1,125 facilities in the Central Basin.

About 64% of dairy farms are small operations, producing less than 3,000 liters/day, equating to 27.5% of total production.<sup>74</sup> In 2021, larger producers (10,000 liters/day) represented 4.8% of

<sup>72</sup> Ministry of Economy, Argentina. (December 2021). Value Chain Reports: Livestock and Meat. Available at: [https://www.argentina.gob.ar/sites/default/files/ficha\\_sectorial\\_carne\\_bovina\\_-\\_diciembre.2021.pdf](https://www.argentina.gob.ar/sites/default/files/ficha_sectorial_carne_bovina_-_diciembre.2021.pdf)

<sup>73</sup> USDA report may be accessed at:

[https://apps.fas.usda.gov/newgainapi/api/Report/DownloadReportByFileName?fileName=Dairy%20and%20Products%20Annual\\_Buenos%20Aires\\_Argentina\\_10-15-2021.pdf](https://apps.fas.usda.gov/newgainapi/api/Report/DownloadReportByFileName?fileName=Dairy%20and%20Products%20Annual_Buenos%20Aires_Argentina_10-15-2021.pdf)

<sup>74</sup> Ministry of Economy, Argentina. (December 2022). Value Chain Reports: Dairy. Available at:

[https://www.argentina.gob.ar/sites/default/files/ficha\\_lacteos\\_-\\_2022\\_-\\_web.pptx.pdf](https://www.argentina.gob.ar/sites/default/files/ficha_lacteos_-_2022_-_web.pptx.pdf)



dairy farms and almost 26% of production, rising from 3.3% and 19.5% respectively just three years prior. In 2021, 75.6% of production was consumed domestically, totaling 189 equivalent liters per capita.

### Swine Production

According to the FAO the swine sector only represents 2% of the livestock population in Argentina in 2007. However, the slaughter, production and apparent consumption and per capita consumption of swine have since set records in 2021.<sup>75</sup> The domestic consumption of pork has increased in recent years, resulting in a 9% annual increase in production from 2008 to 2018.<sup>76</sup>

Pork production is concentrated in central Argentina, coinciding with the availability of grains and slaughter and consumption centers. Buenos Aires, Cordoba, and Santa Fe have 63% of the swine population<sup>77</sup> and 85% of industrial production.<sup>78</sup> According to Rosario Stock Exchange, there are 249 swine processing facilities in Argentina, where 49% of the total pork production is produced within 5 facilities, 4 of which are located in Buenos Aires (2018).<sup>79</sup> As of March 2022, there were over 5.4 million pigs in Argentina across 24 provinces, with the highest population located in Buenos Aires at over 1.3 million pigs (SENASA, 2022).

Pork production in the province of Córdoba has grown enormously in the last decade. In 2010 the stock in Córdoba was around 420 thousand heads and today it exceeds 1.3 million. This growth resulted in the province becoming the second national producer of pork with a total of 108 thousand tons of meat per year. According to the data provided by SENASA for the year 2022, Córdoba has a pork stock of 1,369,258 heads distributed in 12,330 establishments.

## C.2 Analysis of Common Practices of Manure Management Systems in Argentina

On December 1, 2021, the Environment Secretariat of the Province of Córdoba launched the Sustainable Actions Program for SICPA Establishments (Intensive Animal Breeding and Production Systems), which aimed to promote good environmental and energy practices at poultry, beef, and swine operations.<sup>80</sup>

---

<sup>75</sup> Bolsa de Comercio de Rosario (March 2022). BCR Argentina Pig Outlook – March 2022. Available at: <https://www.bcr.com.ar/es/mercados/mercado-de-granos/news/bcr-argentina-pig-market-outlook-march-2022>

<sup>76</sup> Ministry of Ecology, Argentina. (July 2019). Value Chain Reports: Pork. Available at: [https://www.argentina.gob.ar/sites/default/files/sspmicro\\_cadenas\\_de\\_valor\\_porcina\\_1.pdf](https://www.argentina.gob.ar/sites/default/files/sspmicro_cadenas_de_valor_porcina_1.pdf)

<sup>77</sup> Baron et al. (2020). Application of network analysis and cluster analysis for better prevention and control of swine diseases in Argentina. *PLoS ONE*, 15(6).

<sup>78</sup> Obtained from: [https://www.pig333.com/latest\\_swine\\_news/how-did-argentinasswinesindustry-fare-in-2023\\_20070/#:~:text=80.5%25%20of%20the%20pigs%20slaughtered,pigs%20processed%2C%20with%206%2C841%2C301%20head.](https://www.pig333.com/latest_swine_news/how-did-argentinasswinesindustry-fare-in-2023_20070/#:~:text=80.5%25%20of%20the%20pigs%20slaughtered,pigs%20processed%2C%20with%206%2C841%2C301%20head.)

<sup>79</sup> Available at: [https://www.bcr.com.ar/es/mercados/investigacion-y-desarrollo/bcr-weekly-news/news-informativo-semanal/look-argentinasswinesindustry-fare-in-2023\\_20070/#:~:text=80.5%25%20of%20the%20pigs%20slaughtered,pigs%20processed%2C%20with%206%2C841%2C301%20head.](https://www.bcr.com.ar/es/mercados/investigacion-y-desarrollo/bcr-weekly-news/news-informativo-semanal/look-argentinasswinesindustry-fare-in-2023_20070/#:~:text=80.5%25%20of%20the%20pigs%20slaughtered,pigs%20processed%2C%20with%206%2C841%2C301%20head.)

<sup>80</sup> Final Report of the Program available at [https://ambiente.cba.gov.ar/wp-content/uploads/2023/12/Acciones\\_Sustentables\\_Informe\\_Establecimientos\\_SICPA\\_2022-1.pdf](https://ambiente.cba.gov.ar/wp-content/uploads/2023/12/Acciones_Sustentables_Informe_Establecimientos_SICPA_2022-1.pdf)

The Sustainable Actions Program concluded that approximately 63% of the participating establishments generate solid livestock waste and 69% of the SICPA establishments generate liquid livestock waste. For solid livestock waste, the Program emphasized the use of composting, solarization or automatic composters to stabilize residue and the subsequent application of the stabilized effluent. However, only 11% of the facilities applied these recommendations. Similarly, for liquid livestock waste, only 14% of the participants implemented the programs recommendation's, which included separating rainwater from livestock liquid waste, implementing an effluent treatment system (i.e., lagoon), optimizing current treatment systems, land application of stabilized effluent, and improved effluent application practices.

Likewise, in a study carried out in 15 commercial bovine production establishments in the Metropolitan Region of Buenos Aires, it was found that 93.3% of producers convey the liquid waste generated to one or more lagoons. These lagoons are intended for evaporation and reabsorption of the waste, discharge to the ground or irrigation of crops.<sup>81</sup>

Non-dairy cattle make up the majority of methane emissions from livestock manure management (82%), followed by swine (4.1%), horses (4.02%), and dairy cattle (3.48%).<sup>82</sup>

### C.3 Use of Biodigesters in Argentina

According to the National Survey of Biodigesters (FAO, 2019),<sup>83</sup> it is estimated that there are 105 biodigesters of varying sizes (from less than 100 m<sup>3</sup> to reactor volumes greater than 1000 m<sup>3</sup>), technologies, uses, and applications. However, only 1% of livestock operations in the Argentina use biodigesters.

The study analyzed 61 of the existing plants and found that 4% of the plants installed their biodigester for energy, while 96% cite other environmental aspects as the main cause of their adoption. Of the digesters, 37.5% contain industrial waste, 28.1% urban organic waste, and 26.6% livestock waste (i.e., 16 digesters). The most used technologies are 46% complete mixture type reactors and 19% covered lagoon reactors.

Historically, livestock farming in Argentina was characterized as extensive, however, in recent years there's been a shift to more intensive productive systems, including, among other factors, the expansion of land dedicated to agriculture requiring the change in practices.<sup>84</sup> Considering the current stock of farms, intensive systems dominate a large part of livestock production, for which only around 16 biodigesters have been installed.

Figure C.2 shows the participation by number of biodigesters by province. There was no record of anaerobic biodigesters in the following provinces: Catamarca, Santa Cruz, La Rioja, San Juan, Formosa, Chaco and Tierra del Fuego.

---

<sup>81</sup> Ministerio de Ciencia, Tecnología e Innovación Argentina. (2021). Manejo de los residuos en establecimientos de producción bovina. Available at: <https://ri.conicet.gov.ar/handle/11336/190533>

<sup>82</sup> Instituto Nacional de Tecnología Agropecuaria (INTA). (September 2006). Argentina Profile: Animal Waste Management Methane Emissions. Available at: [https://www.globalmethane.org/documents/ag\\_cap\\_argentina.pdf](https://www.globalmethane.org/documents/ag_cap_argentina.pdf)

<sup>83</sup> Available at: [http://www.probiomasa.gob.ar/\\_pdf/Relevamiento%20Nacional%20de%20Biodigestores\\_10-7-2019.pdf](http://www.probiomasa.gob.ar/_pdf/Relevamiento%20Nacional%20de%20Biodigestores_10-7-2019.pdf)

<sup>84</sup> Garcia et al (2021). Waste management in cattle production establishments. CONICET Institutional Digital Repository.



**Figure C.2.** Location of the known biodigesters in Argentina<sup>85</sup>

As of the Protocol adoption (October 2024), there were only two voluntary manure management projects in Argentina.<sup>86</sup> The National Survey of Biodigesters concluded that a primary reason for the lack of biodigesters at livestock operations in Argentina is due to few opportunities for a return on investment and skepticism of biogas as an energy source.

#### **C.4 Recommendation on Performance Standard**

The livestock industry is a major source of global methane emissions. As a consumption of dairy, beef, and pork in Argentina continues to increase, methane emissions are likewise on a trend to continue to increase. While some livestock operators have seen the environmental benefit of installing biodigesters, carbon credits may provide the incentive necessary to increase the number of biodigesters in the country.

<sup>85</sup> Food and Agriculture Organization of the United Nations. (2019). National Survey of Biodigesters.

<sup>86</sup> Projects information available at <https://registry.terra.org/app/projectDetail/VCS/4554> and <https://registry.terra.org/app/projectDetail/VCS/188>

Based on the determination that biogas control systems are not common practice in the jurisdiction in addition to the barriers to entry, the Reserve recommends a practice-based threshold through the installation of a biogas control system.

## Appendix D Data Substitution

This appendix provides guidance on calculating emission reductions when data integrity has been compromised either due to missing data points or a failed calibration. No data substitution is permissible for equipment such as thermocouples which monitor the proper functioning of destruction devices. Rather, the methodologies presented below are to be used only for the methane concentration and flow metering parameters.

### Missing Data

The Reserve expects that projects will have continuous, uninterrupted data for the entire verification period. However, the Reserve recognizes that unexpected events or occurrences may result in brief data gaps.

The following data substitution methodology may be used only for flow and methane concentration data gaps that are discrete, limited, non-chronic, and due to unforeseen circumstances. Data substitution can only be applied to methane concentration *or* flow readings, but not both simultaneously. If data is missing for both parameters, no reductions can be credited.

Further, substitution may only occur when two other monitored parameters corroborate proper functioning of the destruction device and system operation within normal ranges. These two parameters must be demonstrated as follows:

1. Proper functioning can be evidenced by thermocouple readings for flares, energy output for engines, etc.
2. For methane concentration substitution, flow rates during the data gap must be consistent with normal operation.
3. For flow substitution, methane concentration rates during the data gap must be consistent with normal operations.

If corroborating parameters fail to demonstrate any of these requirements, no substitution may be employed. If the requirements above can be met, the following substitution methodology maybe applied:

Duration of Missing Data	Substitution Methodology
Less than six hours	Use the average of the four hours immediately before and following the outage.
Six to 24 hours	Use the 90% lower or upper confidence limit of the 24 hours prior to and after the outage, whichever results in greater conservativeness.
One to seven days	Use the 95% lower or upper confidence limit of the 72 hours prior to and after the outage, whichever results in greater conservativeness.
Greater than one week	No data may be substituted and no credits may be generated.

For livestock projects, both the lower and upper limit must be utilized. For calculating fugitive emissions from the gas management system ( $PE_{CH_4,BCS}$ ), the upper limit should be used. However, for calculating combusted gas ( $CH_{4,destroyed}$ ), the lower limit must be applied.<sup>87</sup>

---

<sup>87</sup> When using the livestock calculation tool, only one value for methane flow can be entered, and is automatically populated into  $PE_{CH_4,BCS}$  and  $CH_{4,destroyed}$ . The *higher* values should be input initially, as this is conservative of the project emissions calculations. However, if the comparison of modeled to measured emissions indicates that reductions will be based off of monitored emissions, then the *lower* value must be substituted and used, as this will result in conservativeness.

## Appendix E Development of the B<sub>0</sub> Sampling and Analysis Methodology

With the release of Livestock Protocol Version 4.0 in January 2013, the Reserve adopted a novel methodology for the sampling and analysis of livestock manure to determine maximum methane potential. In all previous versions of the livestock protocol, in Mexico, the Dominican Republic, and the U.S., the value of this term was defined by the default options provided in Table B.3, which were themselves sourced from the EPA Climate Leaders Draft Manure Offset Protocol. Other than a change in the value of the default for Dairy Cows with Version 2.1 from a “low roughage” value to a “high roughage” value, these default values have not changed since the first version of the protocol was adopted. Reserve staff have received feedback from stakeholders that in many cases, the default value for a particular animal category, especially dairy cows, is excessively conservative. Based on this feedback, the Reserve initiated a process to explore the options for updating the default values for maximum methane potential (B<sub>0</sub>). After review of existing methodologies and literature related to manure methane potential, the Reserve determined that there is currently not a clear basis for establishing different default values. However, direct sampling and analysis were identified as an option that could be immediately provided as an alternative to the existing default values.

In 2009 the Reserve adopted the Organic Waste Digestion project protocol (updated to Version 2.0 in 2011). This protocol introduced a procedure for the determination of site-specific B<sub>0</sub> value for organic wastewater streams (OWD V2.0, Section 6.1.3.2). These requirements formed the basis for the development of a sampling and analysis procedure for livestock projects.

In early September 2012, the Reserve solicited stakeholder interest for participation in the development process for this new methodology. A diverse group of 36 stakeholders representing carbon project developers, academia, government, livestock industry, GHG verification bodies, and others, responded to this request. These stakeholders then received a memorandum detailing the proposed methodology and were invited to a webinar on September 19, 2012 to provide feedback and engage in discussion. A total of 22 individuals participated in the webinar discussion, providing a great deal of feedback and suggestions for improvement.

In addition to the public stakeholder consultation, Reserve staff worked directly with experts in industry and academia to further refine the methodology. The goal was to identify a sampling and testing regime that could consistently provide accurate estimates of the B<sub>0</sub> value of different manure streams, and that would be reasonably practical for implementation.

A subsequent review was performed by Argentina Protocol V1.0 Workgroup to adapt the sampling and analysis methodology for the jurisdiction. The Reserve obtained monthly milk production data from the National Ministry of Agriculture and Livestock and Fisheries in Argentina in order to determine the sampling schedule. The major considerations and decisions in the U.S. Livestock Protocol are addressed below and are applied to data obtained from Argentina.

### Sampling Schedule

The sampling procedure requires that six samples be taken at regular intervals throughout the day. These individual samples are then combined into one composite sample to represent that event. The sampling procedure in the OWD protocol calls for 10 samples spaced out over at least one week. In consultation with expert stakeholders, it was determined that livestock

manure will be less variable over such short timescales, and that the collection of multiple samples in a single day would be sufficient to control for sample variability and error. A more onerous sampling requirement would introduce additional resourcing requirements and costs disproportionate to any reduction in uncertainty/error.

The procedure also requires that the sampling event take place between the months of February through June (inclusive). The Reserve has limited the applicability of this procedure to dairy facilities, and expects that it will mainly be used for the determination of a site-specific  $B_0$  for dairy cows. Thus, the timing of the sampling procedure is designed to avoid overestimating the  $B_0$  value for this particular livestock category. Academic experts advised the Reserve that the methane generating potential of dairy cow manure tends to be positively correlated with milk production.<sup>88</sup> To ensure that the average  $B_0$  value for the year is not overestimated, it is appropriate to avoid sampling the manure during periods of above-average milk production. Reserve staff used data from the National Ministry of Agriculture, Livestock and Fisheries in Argentina. For the years 2015-2023, the milk production for each month (in liters) was compared to the average monthly milk production for that year. This process highlighted the months with above- or below-average milk production, while controlling for the overall trend of increasing milk production year over year. In the U.S. the assessment was made on a per head basis, however, herd count data was unavailable in Argentina. Instead, the workgroup confirmed that the pattern of milk production per liters was representative of overall milk production trends. Figure E.1 shows the results of this analysis and the consistent pattern of milk production during this 9-year period.

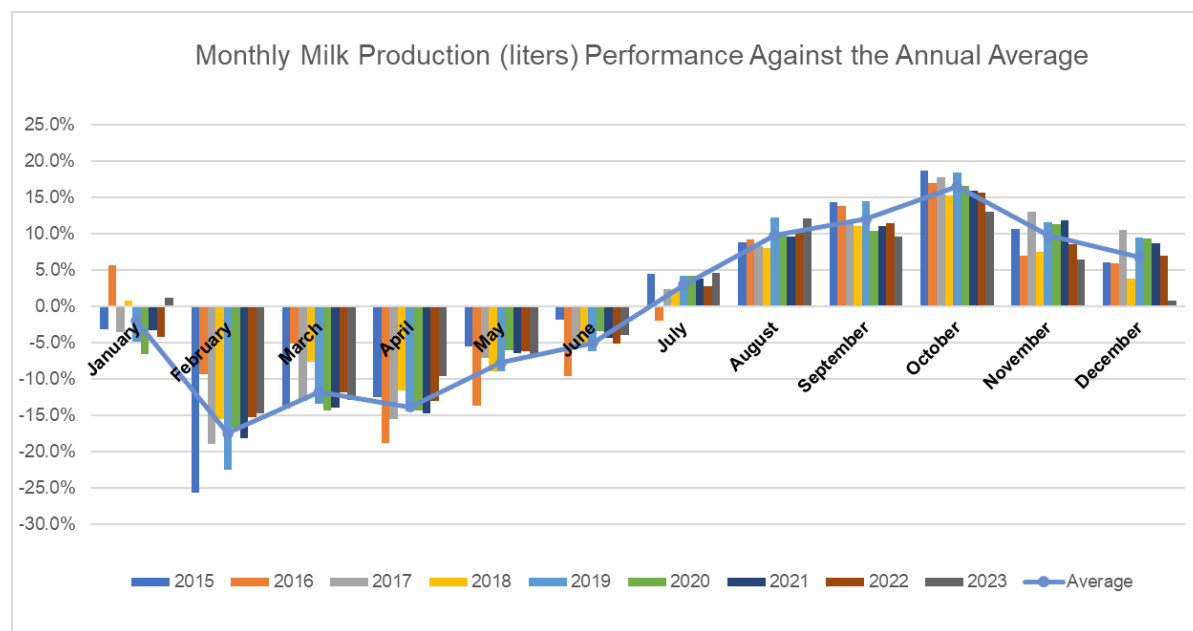

**Figure E.1.** Monthly Milk Production Trends as a Percent Change Over Annual Average Monthly Milk Production (2015-2023)

<sup>88</sup> In the future, it may be possible to develop a default methane potential that is based directly on monthly milk production, though additional research is needed.



Based on this analysis the Reserve has limited the sampling period to February through June. These months consistently exhibit average- to below-average milk production, which should result in a conservative estimate of the annual average  $B_0$  value.

### Sample Source

The procedure instructs the user to obtain a manure sample that represents only a single animal category, prior to mixing with other residues (except for flush water in the case of flush systems). While certain stakeholders indicated through public comment that they would prefer to sample the entire waste stream as it enters the digester, there are two main reasons why this requirement was not amended:

1. The waste stream entering the digester may contain ineligible materials which, while permitted to be processed by the project BCS, should not be represented in the quantification of baseline emissions.
2. The baseline quantification model is run on a monthly basis, using the actual animal population figures for that month. The relative populations of different animal categories may change during the year, resulting in an overall  $B_0$  value for the manure from that facility that is variable through time. To use a composite  $B_0$  value, representative of multiple animal categories, would create quantification inaccuracies if relative populations change from one month to the next (see Table E.1)

**Table E.1.** Effects of Relative Population Size on Composite  $B_0$  Value

Animal Category	$B_0$ Value	Population in Month 1	Population in Month 2	Population in Month 3
Dairy Cows	0.24	2,000	800	3,000
Heifers	0.17	500	2,000	200
Calves	0.17	500	1,200	0
<b>Composite <math>B_0</math> Value</b>		<b>0.22</b>	<b>0.18</b>	<b>0.24</b>

There is an additional step for dairies that utilize a flush system for manure management, as the flush water is typically composed of some type of wastewater, which could have a significant methane potential. For these systems it is necessary to also sample the flush water inlet point prior to mixing with the manure, so that the methane potential of the flush water can then be subtracted from the methane potential of the sample.

### Laboratory Analysis

The Reserve undertook research to determine whether standard procedures/processes existed for the professional analysis of  $B_0$  potential. This research revealed that while there is currently no standard laboratory certification scheme within the US or Argentina pertaining to this type of analysis, there are commonly-accepted methods for undertaking the relevant biochemical

methane potential (BMP) analysis itself. The requirements to document a laboratory's experience and standard operating procedures were introduced to ensure rigor and consistency among testing bodies.

The Reserve consulted with commercial and university testing laboratories regarding the requirements for the biochemical methane potential (BMP) assay. The resulting requirements closely resemble the standard procedures of existing laboratories. It is necessary for the protocol to prescribe at least basic parameters for the BMP assay in order to ensure consistency among projects that hire different laboratories. The inclusion of a control assay was suggested by multiple laboratories as an important quality check on the viability of the seed inoculum that is used for the BMP assay.

### **Stakeholder Participation**

For a list of the stakeholders that participated in the development of the original methodology, please refer to Appendix E of the U.S. Livestock Protocol V4.0.

## Appendix F Sample Livestock Project Diagram

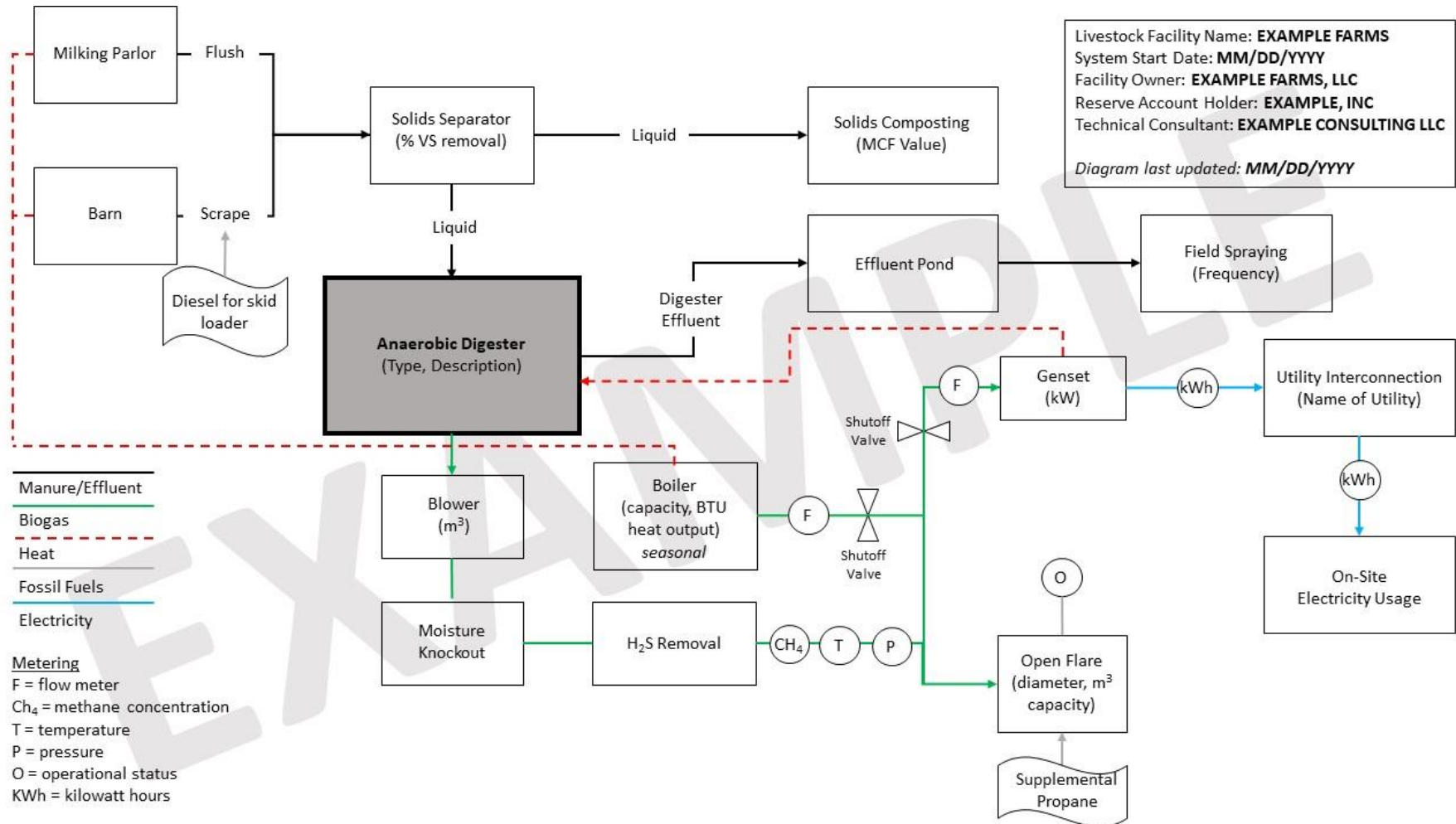

Source: Prepared by the Reserve